



Bathing Rooms



This guide explains requirements in the ABA Standards for bathing rooms.

Required Compliance [§F213]

Plumbing and building codes address the number and type of bathing rooms and fixtures required for a facility. The ABA Standards, on the other hand, address access to bathing rooms where they are provided. In new construction, access is required to all bathing rooms, including those for employees. However, where single user portable units are provided, at least 5% at each cluster must comply and be labelled by the International Symbol of Accessibility (ISA) unless all in a cluster are accessible (§F213.2. Ex. 3, §F216.8).



Unisex Bathing Rooms [§F213.2]

Where multi-user bathing rooms are provided, accessible unisex bathing rooms cannot serve as a substitute for compliant multi-user rooms, except in alterations where making multi-user rooms comply is not technically feasible (§F213.2, Ex. 1). Otherwise, where multi-user and unisex bathing rooms are provided, both types must comply. Unisex bathing rooms, where provided, must have privacy latches and contain a shower or shower and tub, a lavatory, and a water closet (§F213.2.1). Providing an accessible unisex bathing room in addition to accessible multi-user bathing rooms is helpful for those who use personal care assistants of the opposite sex. The International Building Code requires accessible unisex bathing rooms in recreational facilities with separate-sex bathing rooms that have more than one shower or bathtub fixture (§1108.2.1 in the 2000 IBC and §1109.2.1 in later editions).

Additions [§F202.2]

Additions are required to comply with requirements in the Standards for new construction. Each bathing room of an addition must comply as would be required in new construction. If an addition does not include any bathing facility, at least one bathing facility for each sex in the existing portion of the facility must be made accessible to serve the addition; access to a single unisex bathing facility is permitted if there is only one bathing facility in the facility or if providing access to a men's and women's room is technically infeasible (§F202.2, §F213.2 Ex 1).

Alterations [§F202.3]

When existing bathing rooms are altered, the Standards apply according to the planned scope of work. If one bathing room on a floor is altered, the Standards apply to that room only; if all bathing rooms on a floor are altered, the Standards apply to each bathing room that would be required to comply in new construction. The scope of work also determines which technical requirements apply. If some, but not all, elements in a bathing room are altered, only those elements altered must comply. If a room or space is completely altered (or built new as part of an alteration), the entire room or space must comply.



Recommendation: While only those elements altered are required to comply, it is advisable to maximize opportunities for accessibility in alterations. Alteration of multiple elements in a room or space may provide a cost-effective opportunity to make the entire room or space fully accessible.

Compliance in an alteration is not required where it is “technically infeasible.” The term is defined as “something that has little likelihood of being accomplished because existing structural conditions would require removing or altering a load-bearing member that is an essential part of the structural frame; or because other existing physical or site constraints prohibit modification or addition of elements, spaces, or features that are in full and strict compliance with the minimum requirements.” When it is technically infeasible to make existing men's and women's bathing rooms comply, an accessible unisex bathing room can be provided instead if it is in the same area and on the same floor as the existing bathing rooms (§F213.2, Ex. 1). If technical infeasibility is encountered, compliance is still required to the maximum extent feasible. Where existing bathing rooms in an alteration do not comply, signs with the International Symbol of Accessibility (ISA) must be provided indicating the location of the nearest accessible bathing room. Those that comply must be labeled by the ISA (§F216.8).

Bathing Room Location

The Standards do not generally require bathing rooms to be provided in a specific location. However, in multi-story facilities that are exempt from the requirement for vertical access between stories based on the story count or square footage per floor (§F206.2.3, Ex. 1 or 2), if a bathing room is provided on an inaccessible story, a bathing room also must be provided on an accessible story so that it is connected to an accessible entrance by an accessible route (§F213.1). Bathing rooms provided on other stories must fully comply as well.

Bathing Fixtures [§F213.3]

Bathing facilities must have at least one compliant shower compartment or bathtub. In transient lodging guest rooms, a portion of accessible guest rooms must have a roll-in shower with a folding seat (§F224.2).

Components of an Accessible Bathing Facility

Requirements in the Standards address doors, turning space, plumbing fixtures, mirrors, dispensers, shelves, and other elements provided.

Other provisions in the Standards also apply.

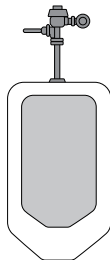
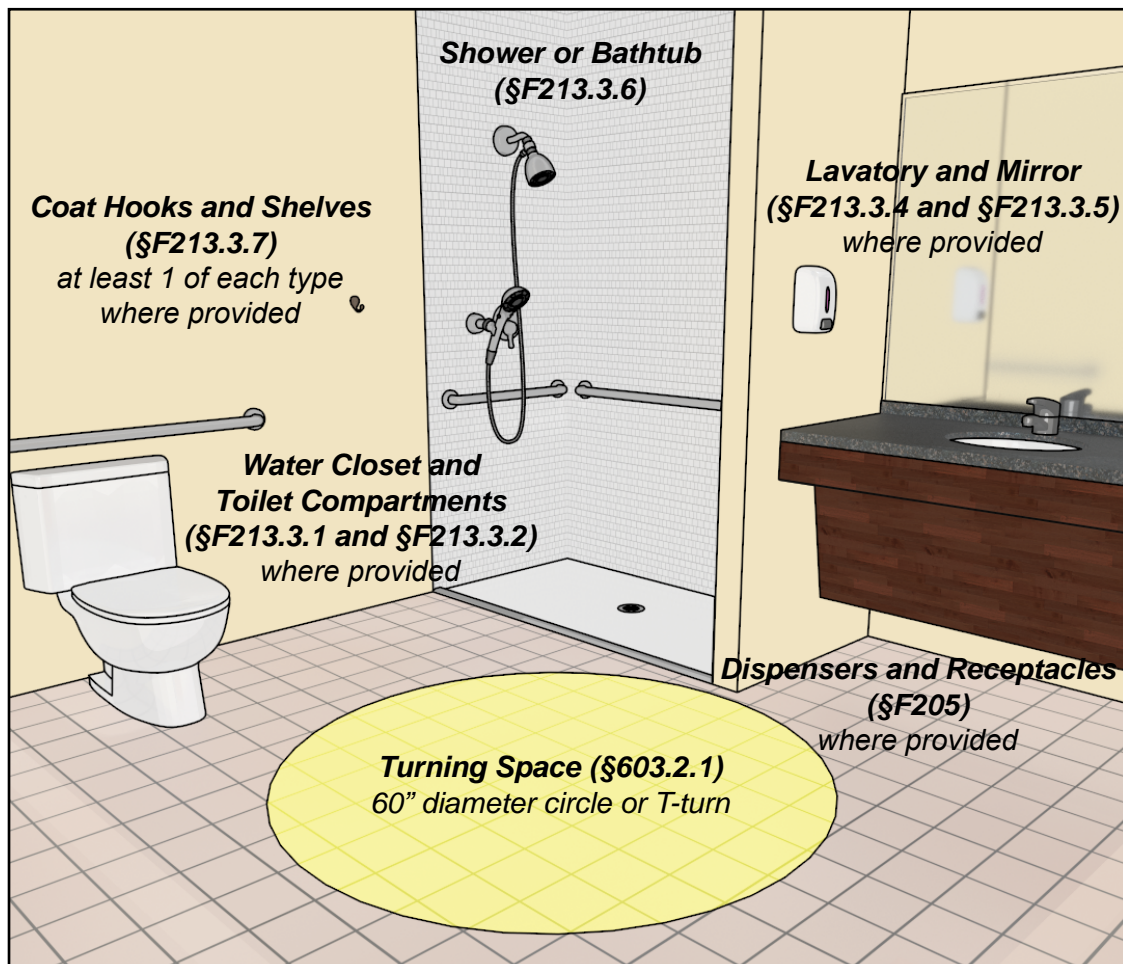

Urinals (§F213.3.3)

An accessible urinal is required only in bathing rooms where more than one urinal is provided.

Roll-In Shower Compartments [§608]

Roll-in shower compartments provide access for shower chairs and other wheeled mobility aids without the need to transfer to a seat. The Standards provide specifications for a standard type and an alternate type of roll-in compartment.

A seat can be provided in roll-in showers (and is required in those roll-in showers that must be provided to serve a portion of accessible transient lodging guest rooms). If a seat is provided, it must be folding so that it does not impede use with a shower chair or other wheeled mobility aid.

Standard Roll-In Shower Compartment



Recommendation: Providing a folding seat in roll-in shower compartments offers greater usability by allowing transfer options. The ICC ANSI A117.1 Standard, which is referenced by the International Building Code, requires a folding seat in each roll-in shower compartment.

Size and Clearance

The compartment size and the required clearance adjacent to the open face of the compartment permit maneuvering into the shower with shower chairs or wheelchairs. The clearance must abut, or be close to, the shower entry but may be slightly forward of the shower to accommodate tile edges or flanges around the face of prefabricated showers.

Note: Dimensions measured to the center point (vertical and horizontal) of opposing walls.

A compliant lavatory can overlap one end of the clearance but cannot be adjacent to controls (or a folding seat).

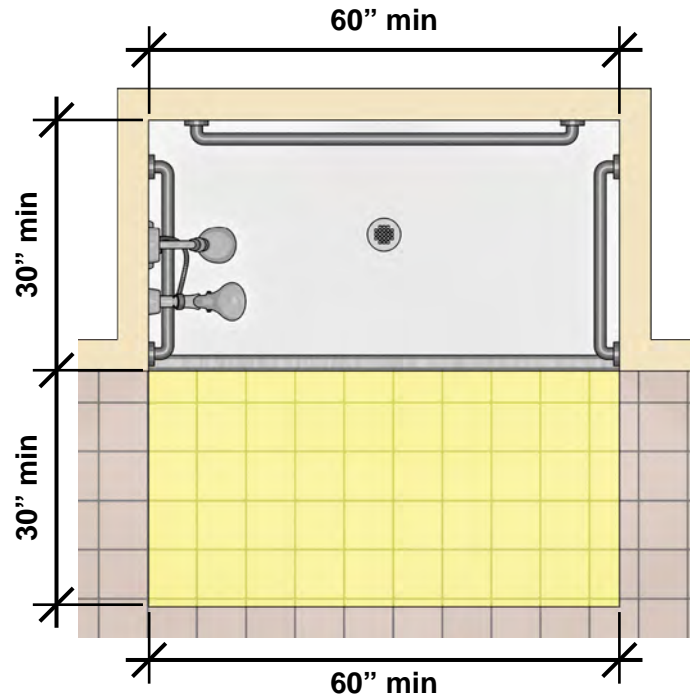

Grab Bars

Grab bars are required on three walls in standard compartments without a seat. Grab bars can be continuous or separate. If separate, they must be 6" maximum from adjacent walls and each must be at the same height above the finish floor. The grab bars must extend across the side wall to the entry. A maximum distance of the grab bar from the shower entry is not specified, but they are to be installed near the entry.

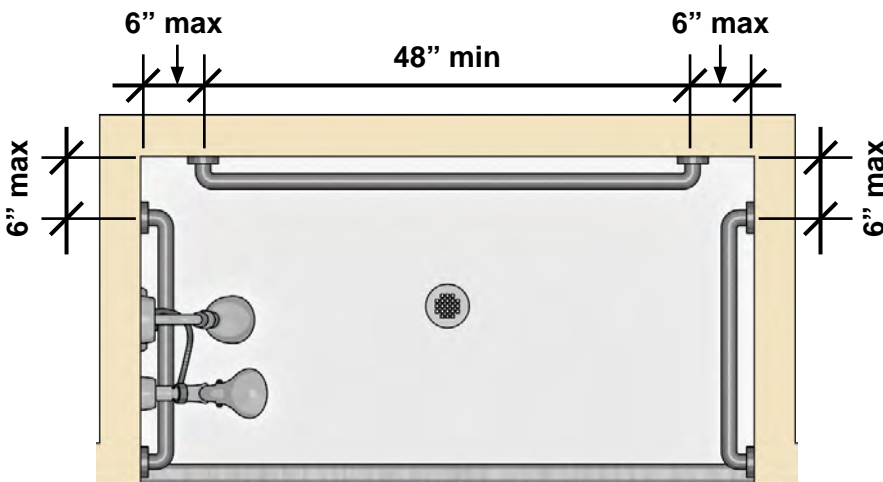

Note: Grab bar to extend to shower entry (distance from entry not specified)

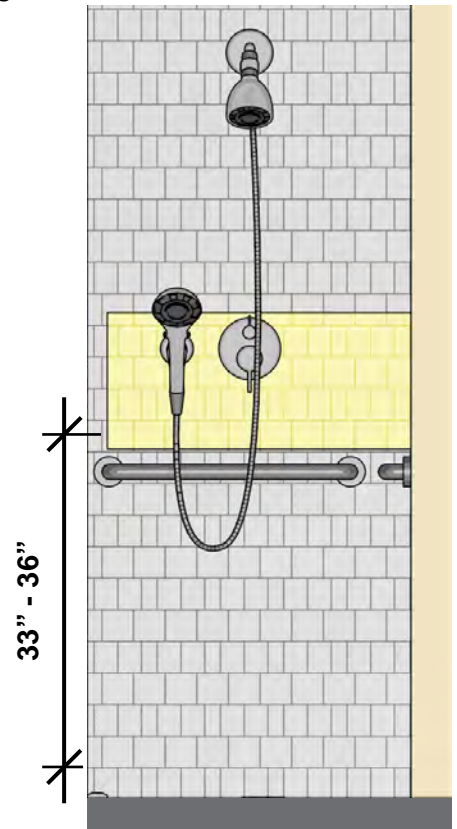

Controls and Enclosures

In a standard roll-in compartment without a seat, the controls, faucet, and shower spray unit can be located on any of the three walls. They must be located above grab bars and within accessible reach range. Shower controls and fittings must be at least 1½” above the grab bar so that they do not impede the bar’s gripping surface. Enclosures cannot obstruct controls, faucets, shower spray units or transfer to seats.

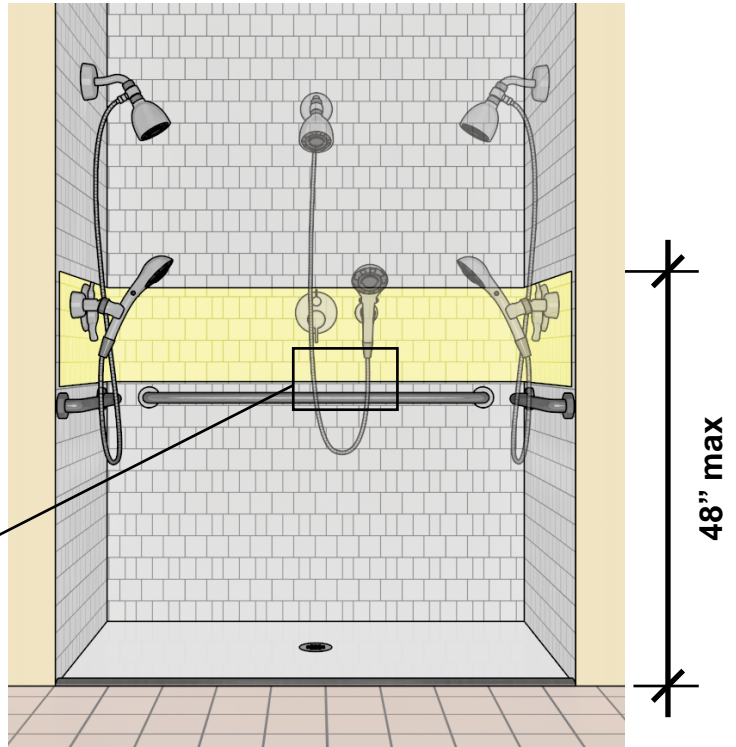
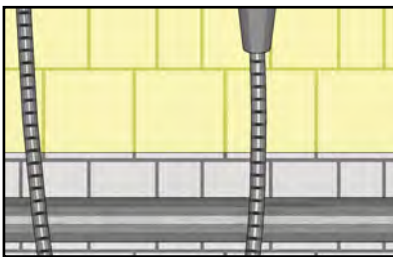

Thresholds

Thresholds at roll-in showers must comply with specifications for changes in level to allow access to wheeled mobility aids. While a threshold height up to ½” (if properly beveled) is permitted, trench drains and other designs that allow a flush transition to the shower floor will provide easier access. Shower floors can slope to drains (a 1:48 maximum slope will help control water without impacting accessibility). Where floor drains are provided in bathing rooms, it is important that the slope of the floor not exceed the 1:48 minimum cross slope.

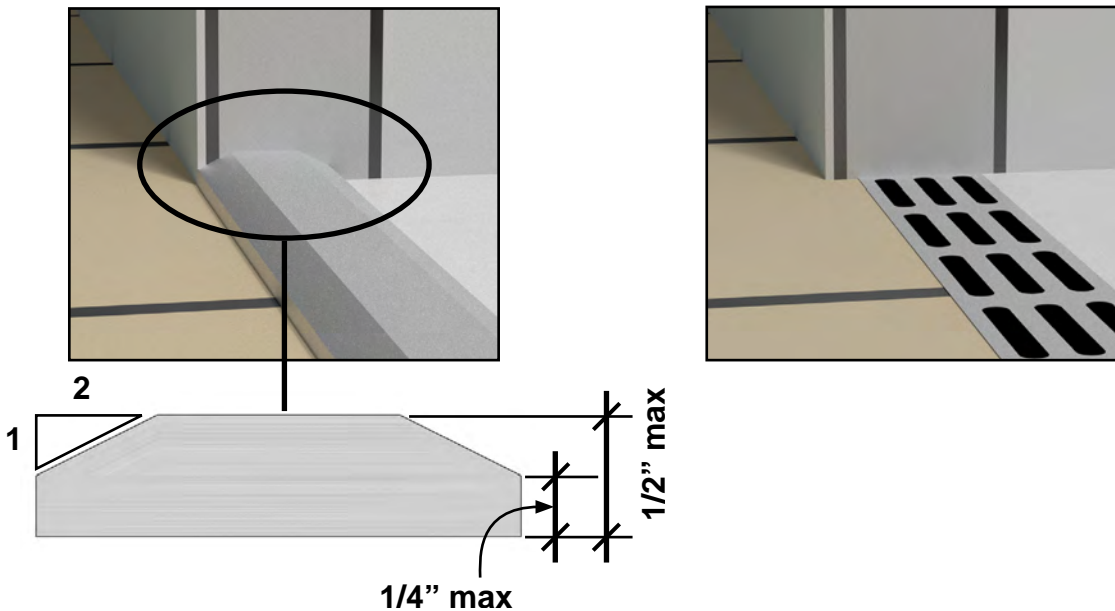

Standard Roll-In Shower Compartment with Folding Seat

Equipping roll-in showers with folding seats enhances usability by providing a transfer option. This is helpful since many wheeled mobility aids are not usable in showers. If provided, the seat must be folding, attached to the wall, and extend to within 3" of the entry. In standard compartments, it must be located on a side wall. The controls, faucet, and hand-held shower spray unit are required to be on the back wall as specified so that they are usable from the seat. Grab bars cannot overlap the seat and are required on the side opposite the seat and on the back wall to the front edge of the seat.

 **Recommendations:** Provide folding seats in all roll-in showers for better access. Soap dispensers and shelves, where provided in roll-in showers, should be within reach from the seat.

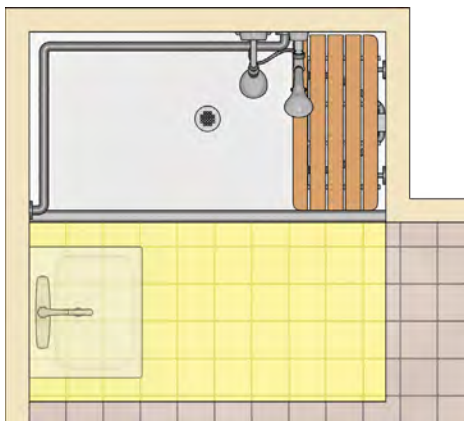
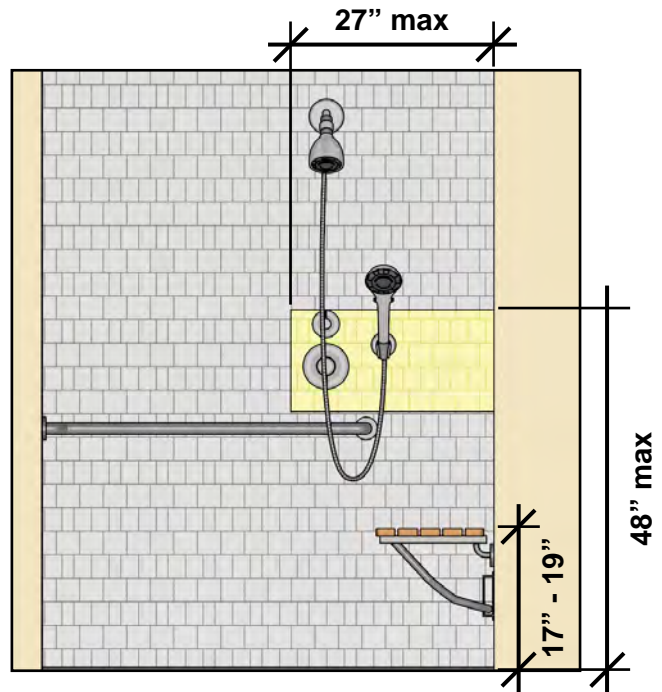

A compliant lavatory can overlap the clearance on the side further from the seat (locating it on the seat side would obstruct transfer). In a compartment without a seat, it cannot overlap the side of the clearance adjacent to controls.

 **Recommendation:** Keep lavatories outside the clearance at roll-in showers for easier access.

Alternate Roll-In Shower Compartment

The alternate compartment design allows the shower opening to be partially enclosed on one side. An entry at least 36" wide is required at one end for maneuvering into the shower. The controls, faucet, and shower spray unit are located on the side wall farther from the entry. As with the standard roll-in compartment, a folding seat can be provided.



Note: Side wall not shown for clarity.

Size and Clearance

The compartment entry and dimensions provide space for making a right angle turn into the shower using wheeled mobility aids.

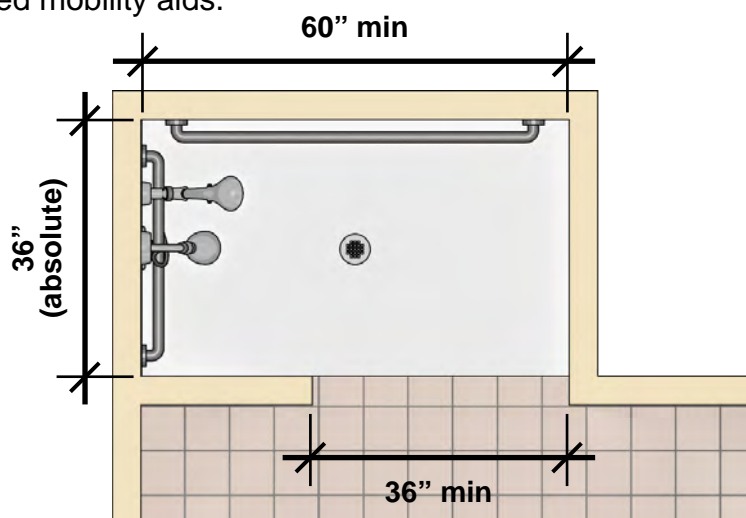

Note: Dimensions measured to the center point of opposing walls.

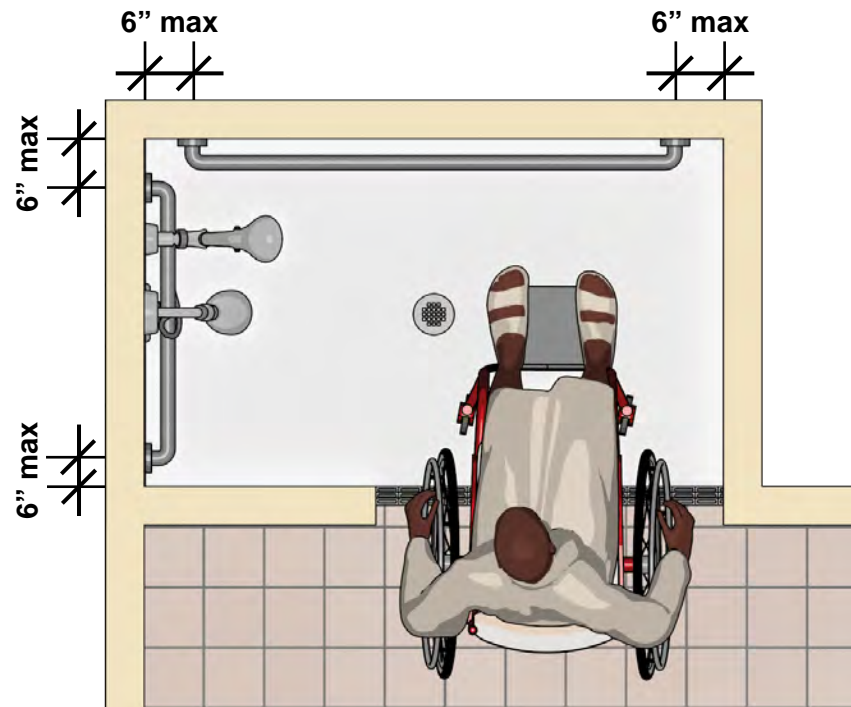

Grab Bars

Grab bars are required on the back wall and the side wall farther from the entry. Grab bars can be continuous or separate. If separate, they must be 6" maximum from adjacent walls and must be at the same height above the finish floor.

Controls, Enclosures, Thresholds

The controls, faucet, and shower spray unit must be located on the side wall farther from the entry if no seat is provided. Shower controls and fittings must be at least 1½" above the grab bar so that they do not impede the bar's gripping surface. Enclosures cannot obstruct controls, faucets, shower spray units or transfer to seats. As with standard roll-in compartments, thresholds must comply with specifications for changes in level (i.e., ½" high maximum and, if greater than ¼" high, beveled 1:2 max).

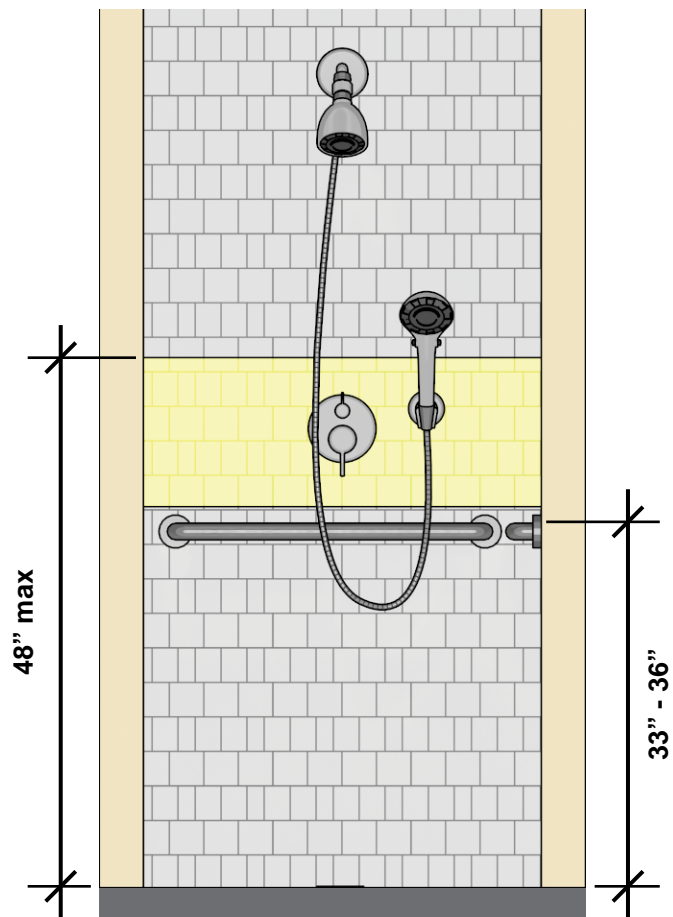

Alternate Roll-In Shower Compartment with Folding Seat

If provided, a folding seat must be mounted on the front wall and extend to within 3" from the compartment entry. The width of the front wall is not specified, but where a seat is provided it should be wide enough to accommodate a folding seat of sufficient size.



Note: Side wall not shown for clarity

A benefit of the alternate compartment is that it provides a grab bar within reach from the seat on the opposite wall. The grab bar on the side wall is dimensioned so that it does not overlap the seat when down. With a folding seat, the controls, faucet, and shower spray unit can be located on the back wall opposite the seat instead of the side wall.



Note: Front wall not shown for clarity

Whether on the side or back wall, the location of the controls, faucet, and shower spray unit are specified so that they are within reach from the seat.

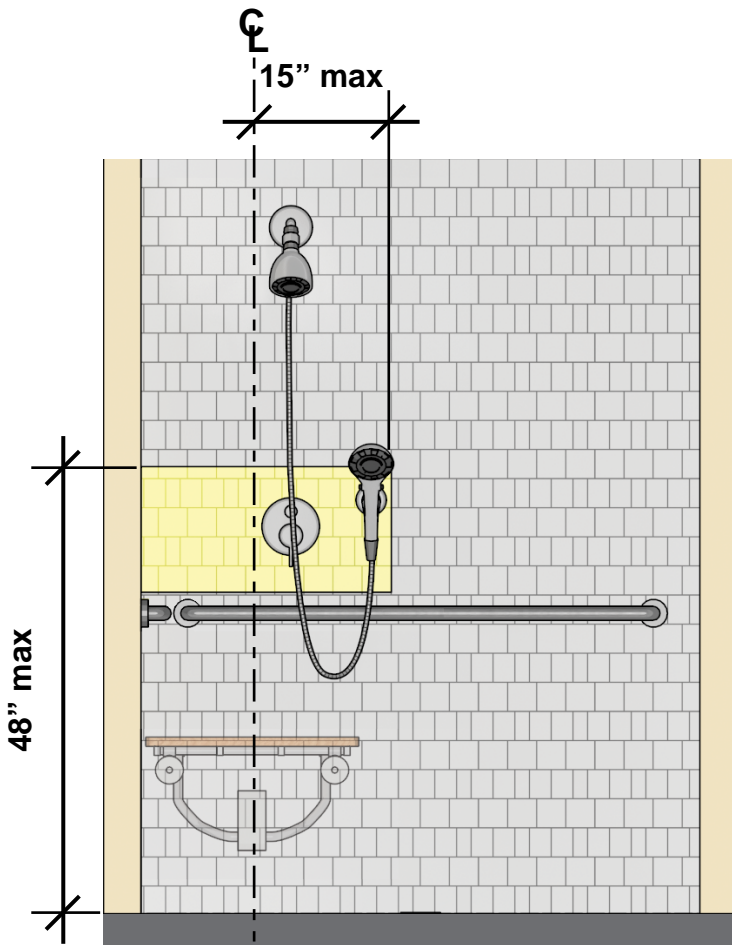

Controls and Shower Spray Unit Opposite Seat

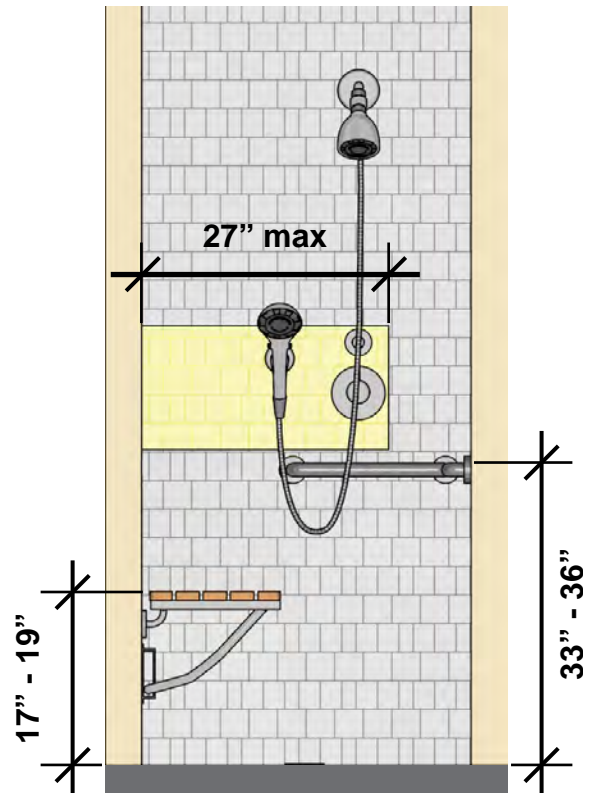

Controls and Shower Spray Unit on Side Wall

Transfer Shower Compartment [§608]

Transfer shower compartments must have a seat (folding or non-folding) and are sized so that controls and grab bars are usable from the seat. The depth is also limited so that support is available from the back wall once transfer is made to the seat. This is why the width and depth are absolute, not minimum, dimensions of 36".



These dimensions are measured from the centerline of opposing walls since prefabricated units often have rounded corners and slightly tapered walls to get the form off the mold. The entry must be at least 36" wide on the face of the compartment.

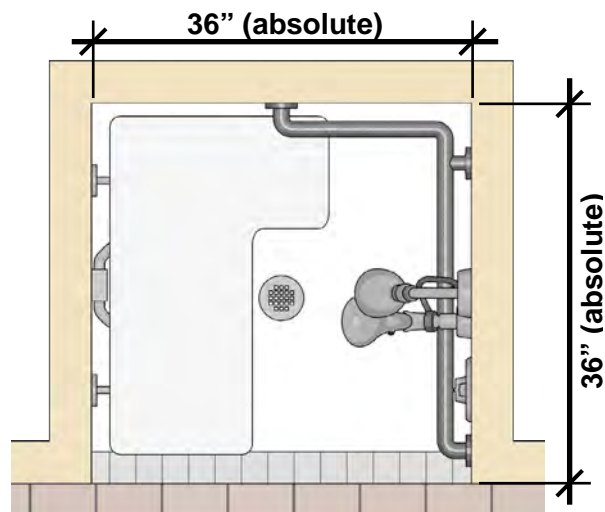

In dwelling units, a seat is not required if walls are properly reinforced to support later installation of a seat in compliance with the Standards (§608.4).



Clearance

The required clearance must be located so that it aligns with the control wall and extends 12" minimum from the seat wall. This allows proper alignment with the seat for transfer from wheelchairs. No elements, including lavatories, can overlap this clearance as they would impede transfer. The seat wall or the flange around the face of prefabricated showers may slightly offset the clearance from the shower. It is important that this offset be minimized and to limit the gap between the clearance and the edge of the seat (which must extend to a point within 3" of the compartment entry).

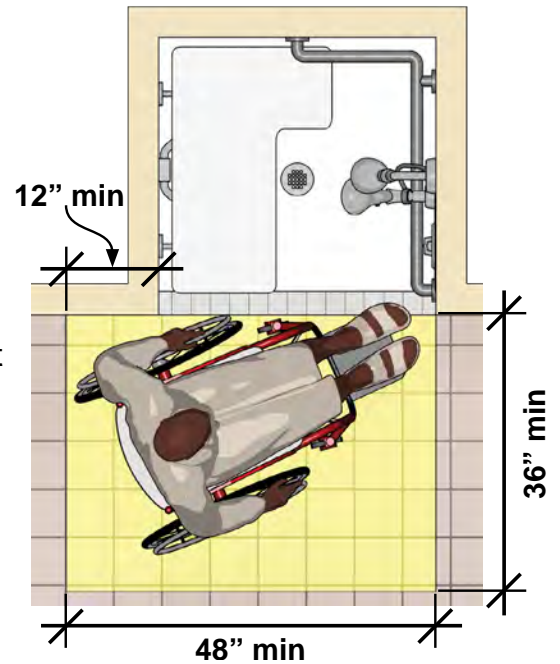

Grab Bars, Controls, and Enclosures

Grab bars are required on the wall opposite the seat and the back wall. They can be continuous or separate. If separate, they must be at the same height above the finish floor. The grab bars must extend across the control wall to the entry. If separate, the grab bars must extend as close as possible to the adjacent wall. Controls are located so that they are within reach from outside the compartment. Enclosures cannot obstruct controls, faucets, shower spray units, or transfer to seats.

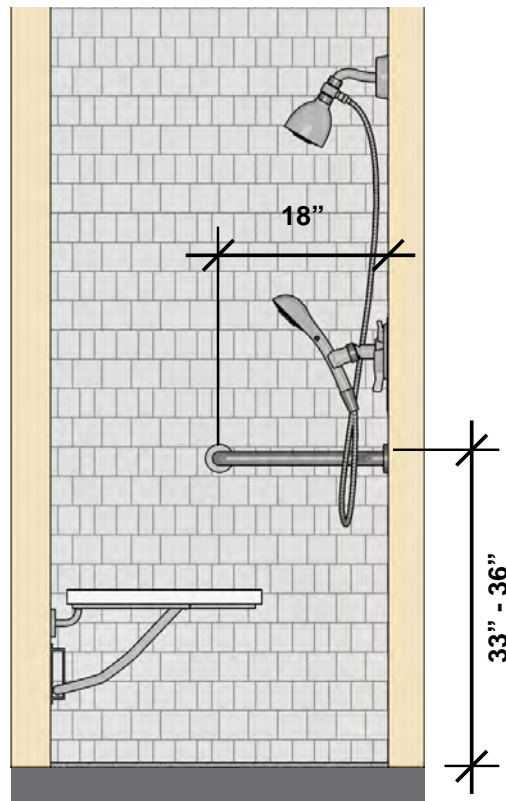
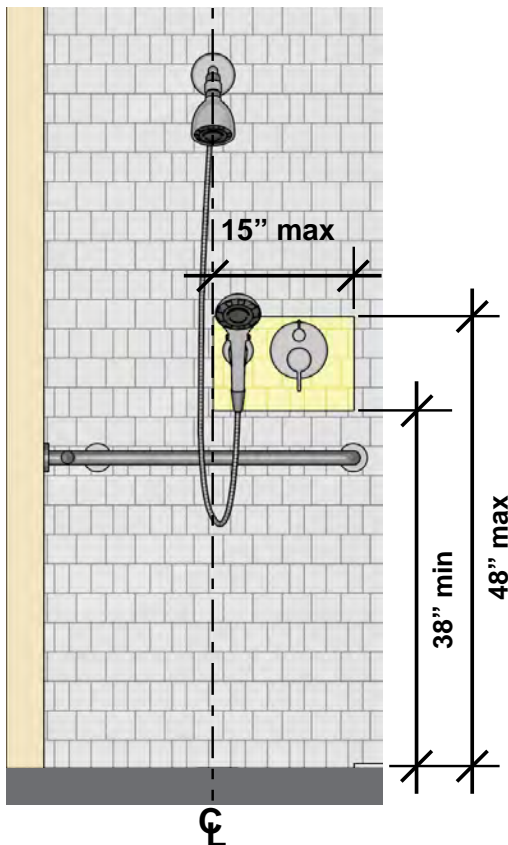

Thresholds

Thresholds are limited to a height of $\frac{1}{2}$ " and can be beveled, rounded, or vertical. No width is specified for the threshold.

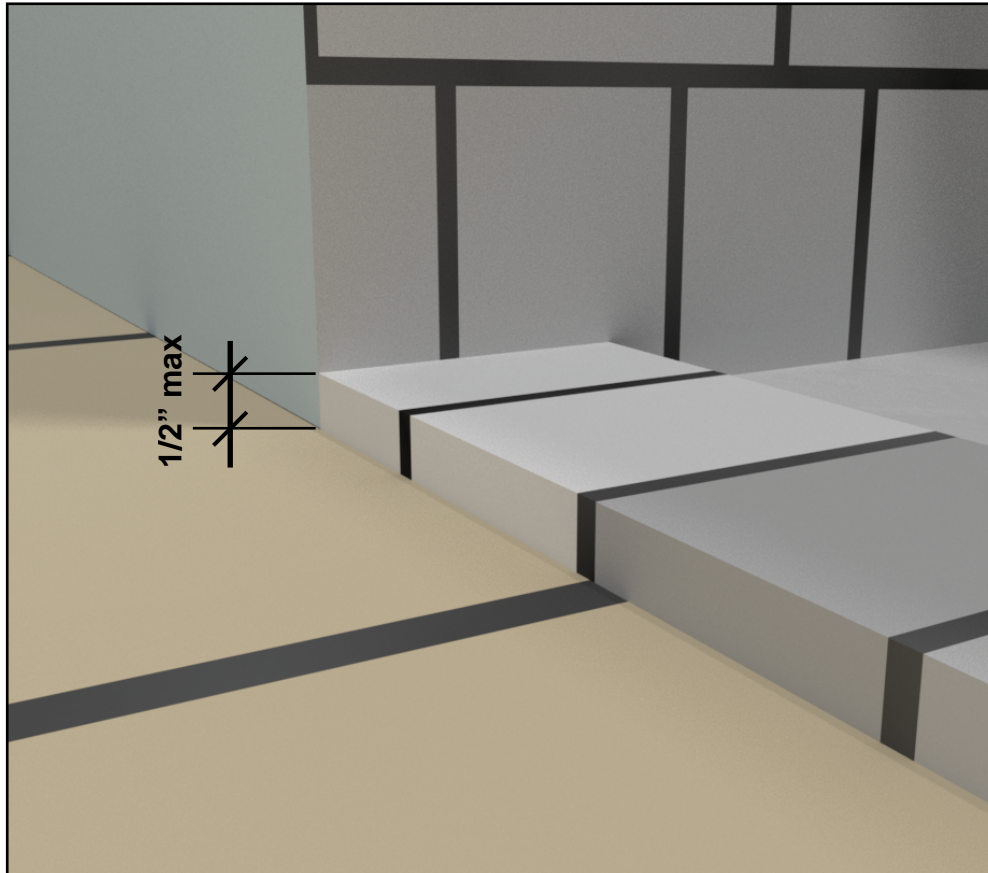

Note: A threshold 2" high max. is permitted in alterations where providing a $\frac{1}{2}$ " threshold would disturb the structural reinforcement of the floor slab

This guide notes some provisions in the International Building Code (IBC) and the *ICC A117.1 Standard for Accessible and Usable Buildings and Facilities* that are not found in the ABA Standards. For example, the A117.1 standard, which provides technical provisions and is referenced by the IBC, requires a vertical grab bar at showers and bathtubs. It also requires a folding seat in all roll-in showers. Not all differences between the ABA Standards and editions of the IBC and A117.1 standard are noted in this guide.

Gang Showers

Where gang showers are provided, a fully compliant shower is required. Either a transfer compartment or a roll-in compartment can be integrated with a gang shower.

Transfer Compartment at Gang Shower



Note: the seat wall must be high enough to provide sufficient back support at the seat. (Back support at dressing room benches must extend 18" above the seat surface.)

Gang Shower Incorporating Roll-In Compartment

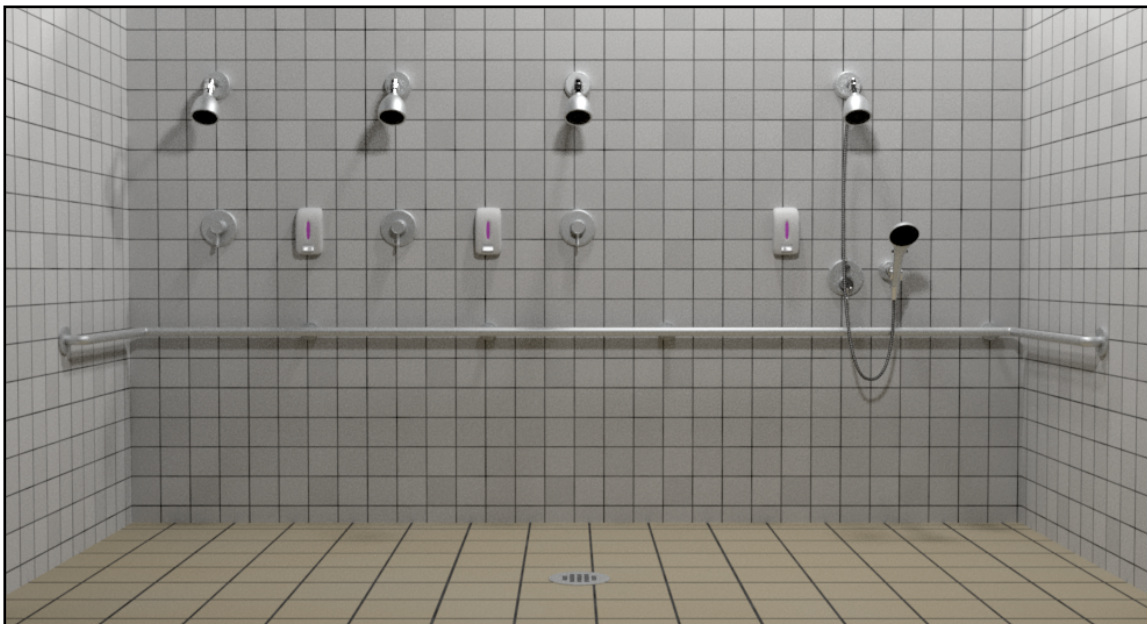

Note: A folding seat can be included in this solution as specified for roll-in compartments.

Controls at Bathtubs and Shower Compartments [§607.5, §608.5]

Controls and faucets at showers and bathtubs must be usable with one hand and not require tight grasping, pinching, or twisting of the wrist, or more than 5 pounds of force (lbf) to operate. Their location is specified so that they are within accessible reach range while not obstructing grab bars and are usable from outside transfer shower compartments and bathtubs.

Shower Spray Units and Water Temperature at Bathtubs and Shower Compartments [§607.6, §608.6]

A hand-held shower spray unit that can also be used in a fixed position is required at all accessible showers and bathtubs. The required on/off control for the hand-held unit must have a “non-positive shut-off” which does not fully stop the flow of water but allows it to be reduced. It also prevents cross-connections and other hazards prohibited by plumbing codes. The water temperature is limited to 120°F.

The hand-held unit needs to be reachable within a height of 48” above the shower floor, measured to the operable portion. Vertical bars with adjustable heights offer more options for using it in a fixed position and are permitted, but they also may result in the hand-held unit being out of reach unless it is returned to a lower position. Vertical bars cannot obstruct use of grab bars and must be at least 1½” above the top gripping surface.



A fixed shower head at 48” maximum above the shower floor can substitute for a hand-held shower spray unit at shower compartments (not bathtubs) in facilities not serving as medical or long-term care facilities, transient lodging, or dwelling units.

Grab Bars [§607.4 and §608.3]

So that use of grab bars at shower compartments and bathtubs is not impeded, any projecting objects must be located at least 12" above the top surface of grab bars and at least 1½" from the bottom and ends of grab bars. However, other grab bars and shower controls and fittings can be located at least 1½" above grab bars.

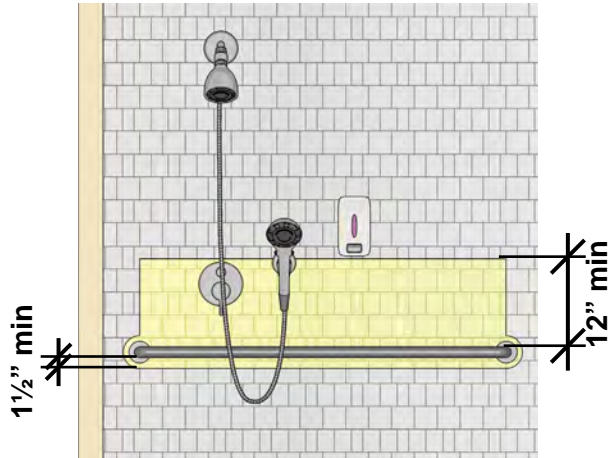

Shower controls and fittings can be 1½" min. above grab bars, but other projecting objects, such as soap dispensers, must be outside the 12" min. clear space above grab bars. This required 12" min. clearance limits to a narrow range (45" – 48") the height of accessible operable parts depending on the grab bar height (33" – 36").

Grab bars can have circular or non-circular cross-sections but must have rounded edges. The 1½" clearance between the grab bar and wall is not a minimum but an absolute dimension to prevent entrapment. Grab bars cannot rotate within fittings. The structural strength of grab bars must withstand a vertical or horizontal force of 250 lbs. at any point on the grab bar, fastener, mounting device, or supporting structure.

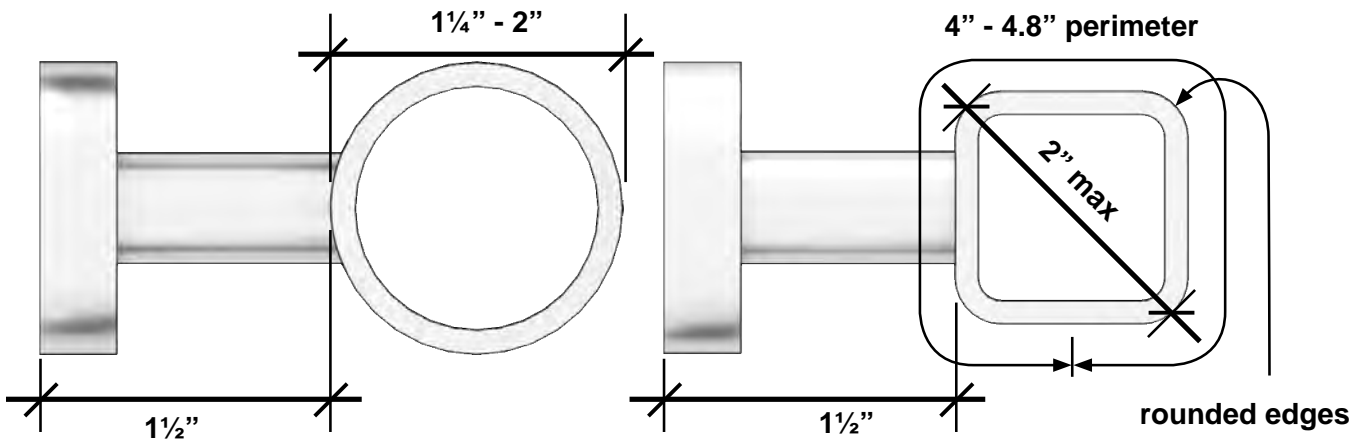

In dwelling units and in single-user bathing facilities accessed only through a private office and not for public or common use, grab bars are not required at showers or bathtubs if walls are properly reinforced for their later installation in compliance with the Standards (§607.4 and §608.3).

Shower Seats [§608.4, §610]

Seats at transfer and roll-in shower compartments can be rectangular or L-shaped. The L-shaped seat affords users additional support and stability from the back wall. To facilitate transfer, the seat height (17" – 19" measured to the bathroom finish floor) approximates wheelchair seat heights. Seats must extend to a point within 3" of the compartment entry to minimize the transfer gap. Seats must withstand a vertical or horizontal force of 250 lbs. at any point on the seat, fastener, mounting device, or supporting structure. Folding seats can have legs.

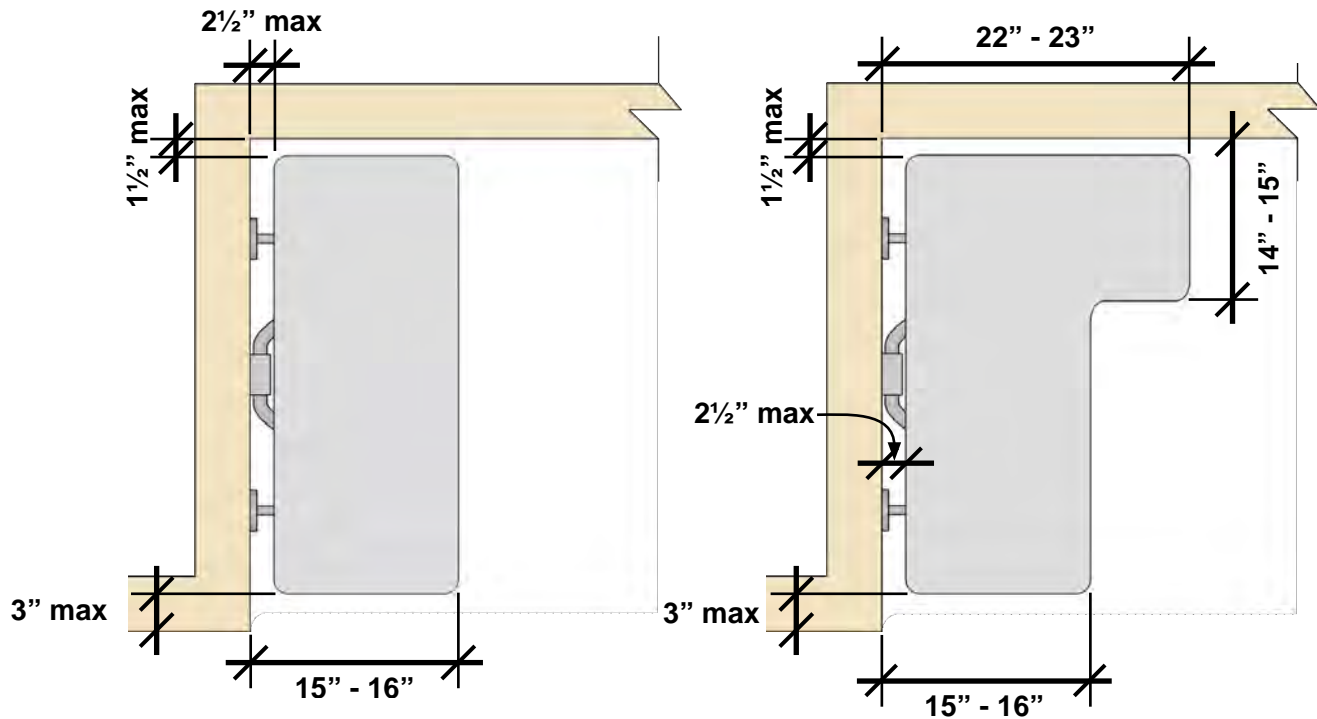

Bathtubs [§607]

Bathtubs must be equipped with a removable in-tub seat or a permanent seat at the head end of the tub.

Removable In-tub Seat

Removable seats must secure to the tub so that they stay in place during transfer and use. Specifications address seat height, depth, and structural strength. Seats must withstand a vertical or horizontal force of 250 lbs. at any point on the seat, fastener, mounting device, or supporting structure. Designs providing back support are advisable but not required.

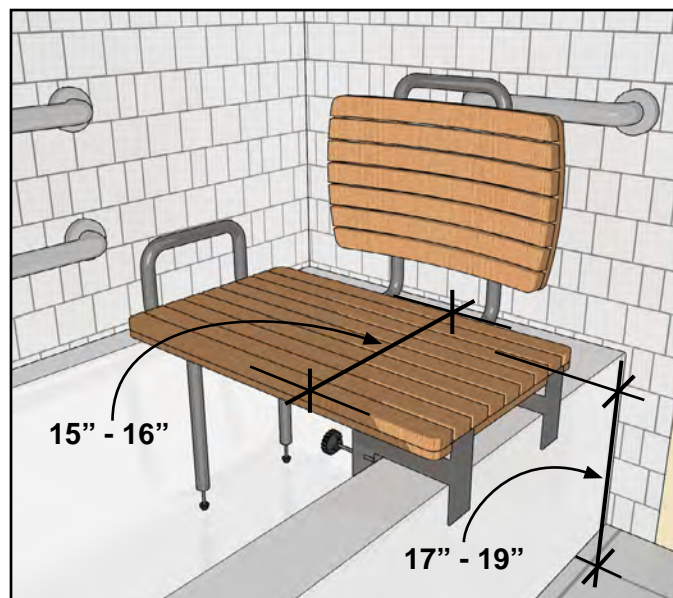

Clearance and Grab Bars

The required clearance at bathtubs provides access to controls and space for transfer to in-tub seats. Grab bars are required on three walls. Those required on the control end and head end walls must be located at the front edge. A compliant lavatory can overlap the clearance at the control end, but keeping this end clear will ease access to controls.

Grab bars on the control end and head end walls must extend to the front edge of the bathtub. A maximum distance from the bathtub front edge is not specified, but the grab bars should be as close as possible while allowing for the bar and attachment to be properly secured.

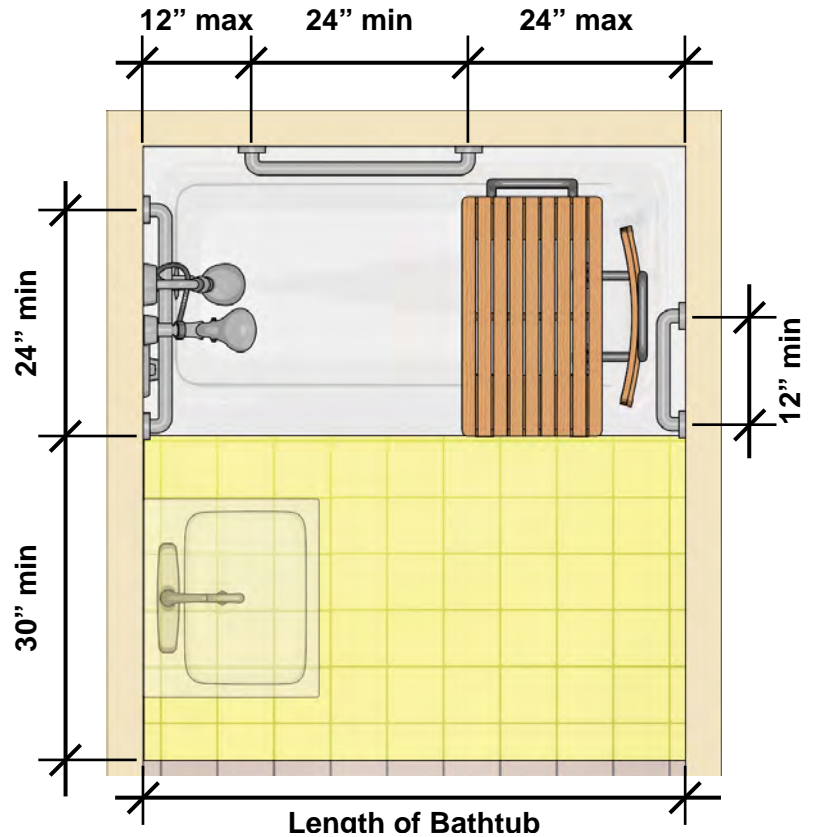

 **Recommendation:** Keep lavatories outside the tub clearance for easier access to tub controls.

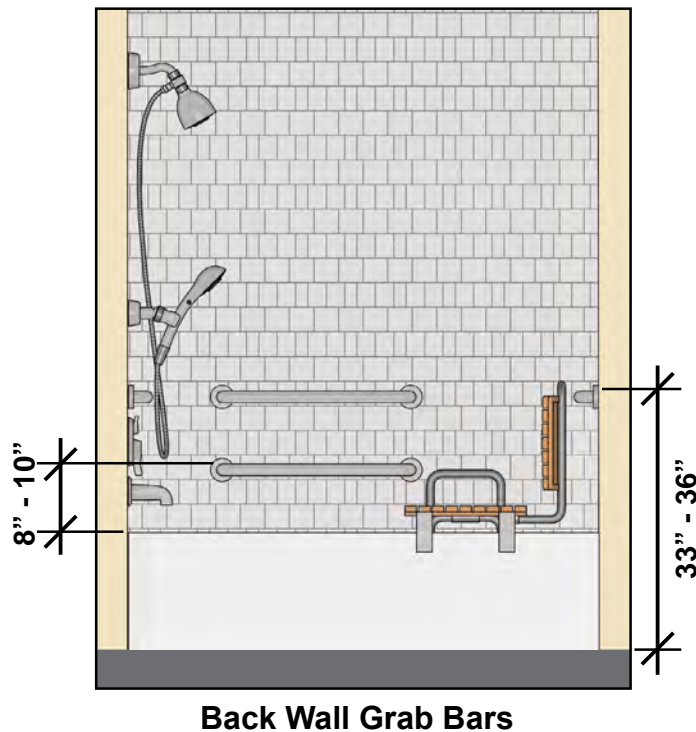

Controls and Enclosures

Controls (excluding drain stoppers) must be located below grab bars toward the front so that they are within reach from outside the tub. Enclosures cannot obstruct controls, faucets, shower and spray units, or transfer to tub seats or into bathtubs or have tracks on the rim of the open tub face.

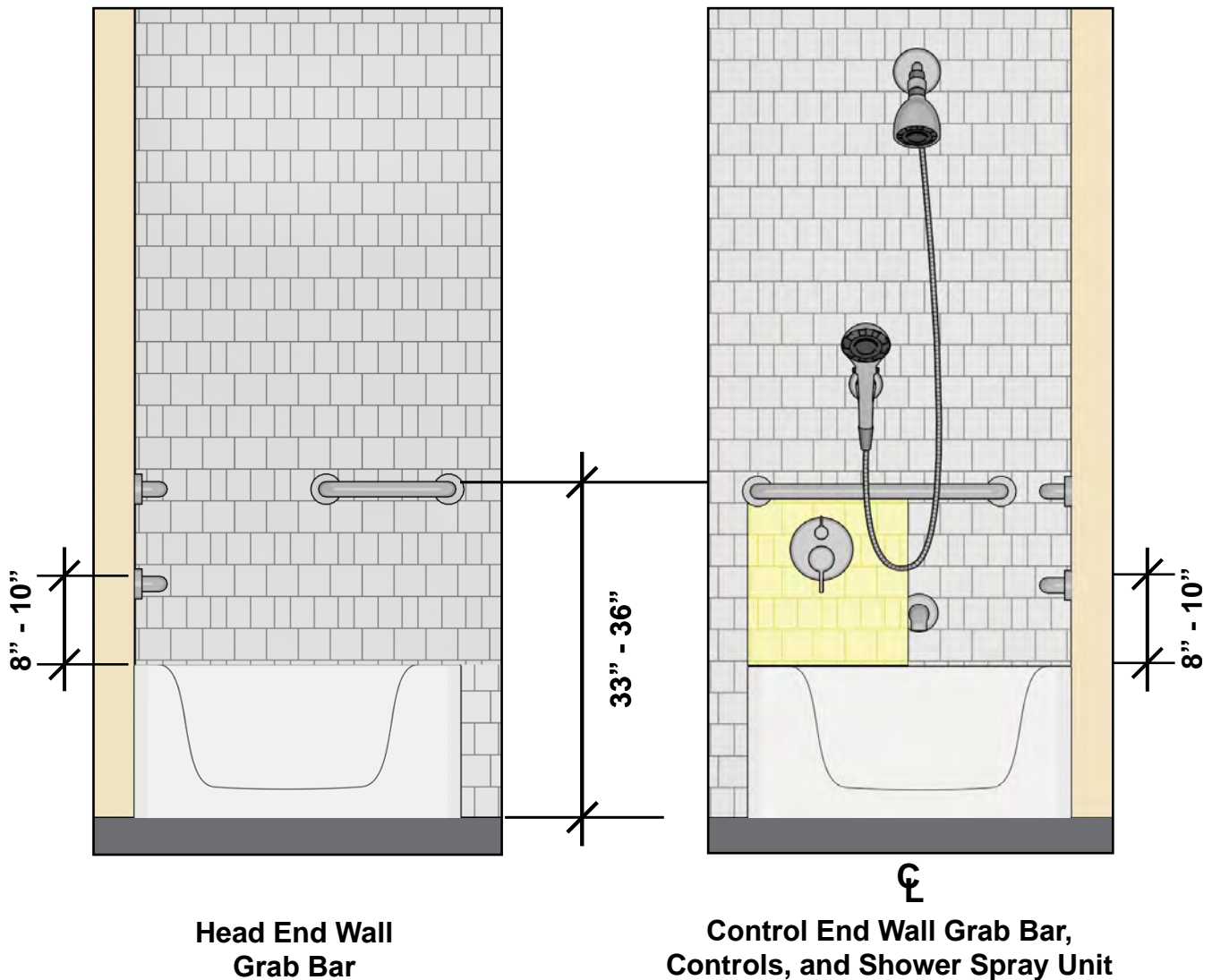

Bathtub with Permanent Seat [§607]

Permanent seats must be located at the head end and extend from the back wall to or beyond the outer edge of the bathtub. Specifications for grab bars and clearances are different for bathtubs with permanent seats. The head end provides back support at the seat and does not contain the 12" minimum grab bar required at bathtubs with removable seats.

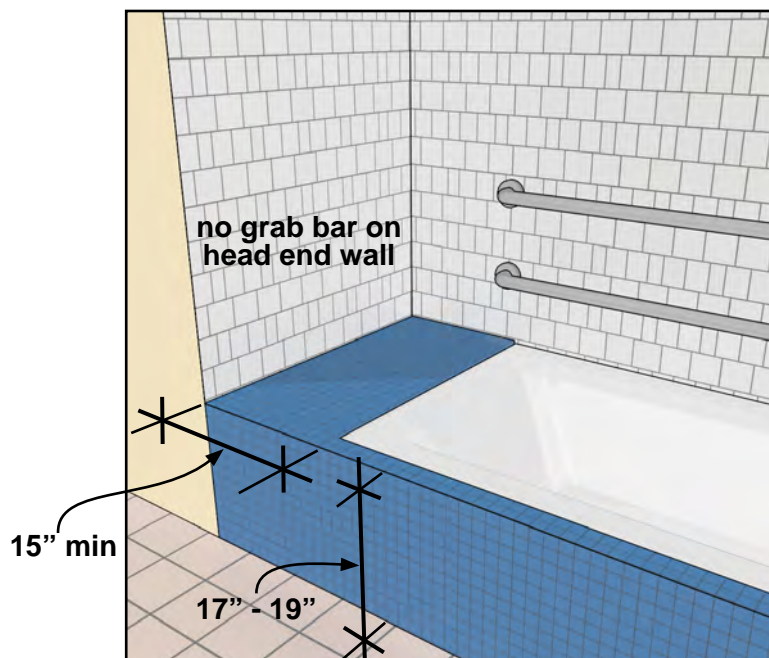

Grab Bars and Clearance

The grab bars on the back wall must extend to 15" maximum from the head end wall so that they are usable from the seat.

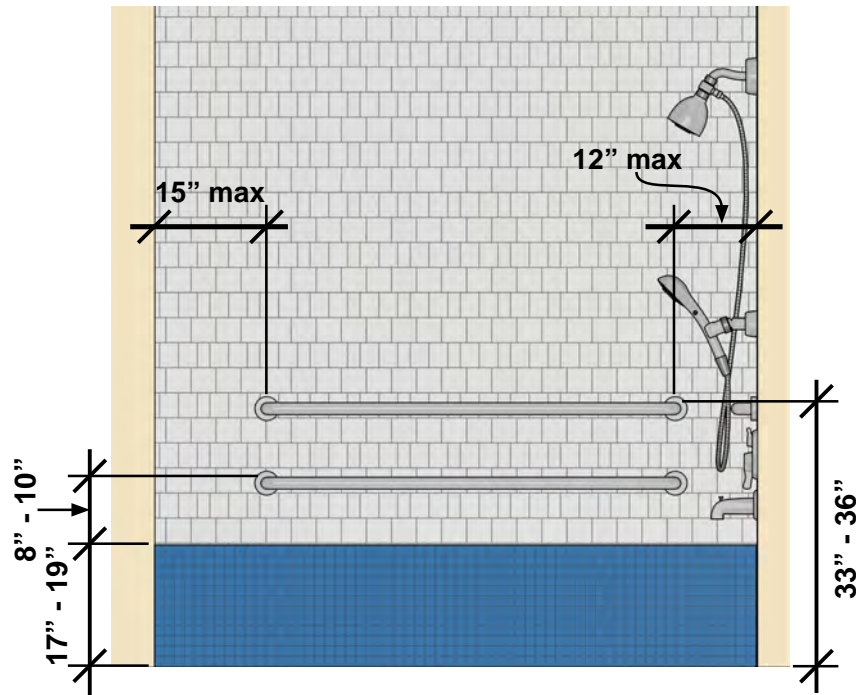

The clearance in front of the bathtub must extend 12" minimum beyond the seat wall so people using wheelchairs can align with the seat for lateral transfer. The seat wall often extends farther than the edge of the bathtub. While the bathtub clearance does not have to abut the bathtub, it is important that any offset necessary for the seat wall be minimized.

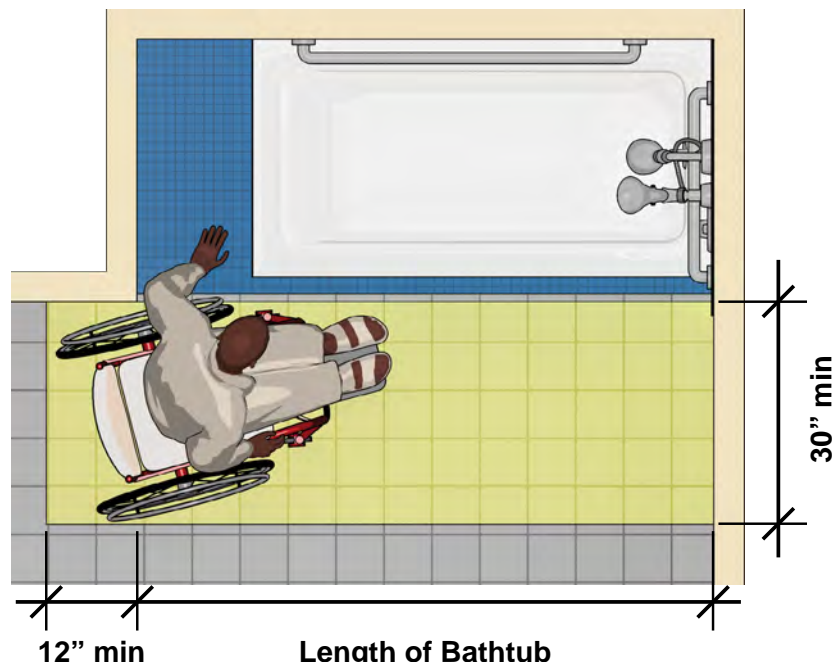

Example Bathrooms

The Standards do not directly specify the size of bathrooms which is determined by the layout, the type and number of fixtures, and other factors and design choices. How various requirements are met, including fixture clearances, turning space, and door maneuvering clearance will determine the minimum dimensions of the room. Bathing facilities, including single-user bathrooms, can be configured in many different ways. The sample layouts shown here are used only as examples of how the technical requirements apply.

Bathroom with Standard Roll-In Shower Compartment

This example of a single-user bathing facility features a standard roll-in shower compartment.

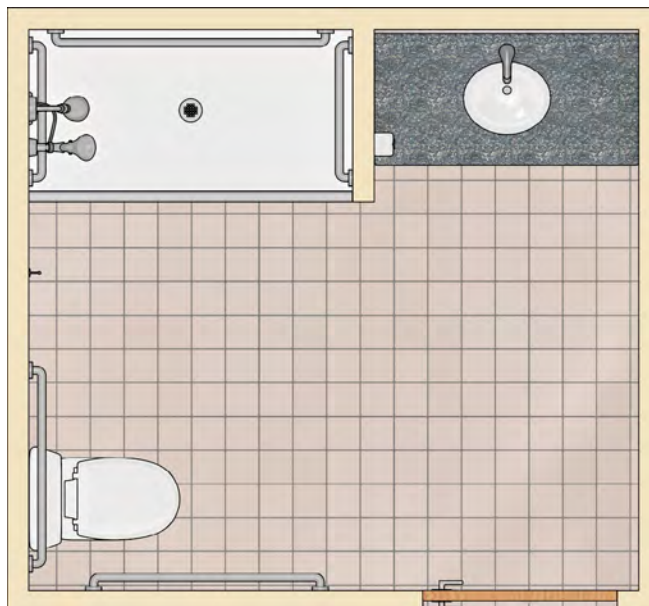

Fixture Clearances

Specified clearances are required at the lavatory, water closet, and shower compartment. Fixture clearances can overlap. The door cannot swing into fixture clearances (unless, in the case of single-user facilities, unobstructed wheelchair space is provided in the room beyond the arc of the door swing). Clear floor space is also required at provided dispensers, receptacles, controls and other operable parts, clothes hooks, and shelves (not shown).

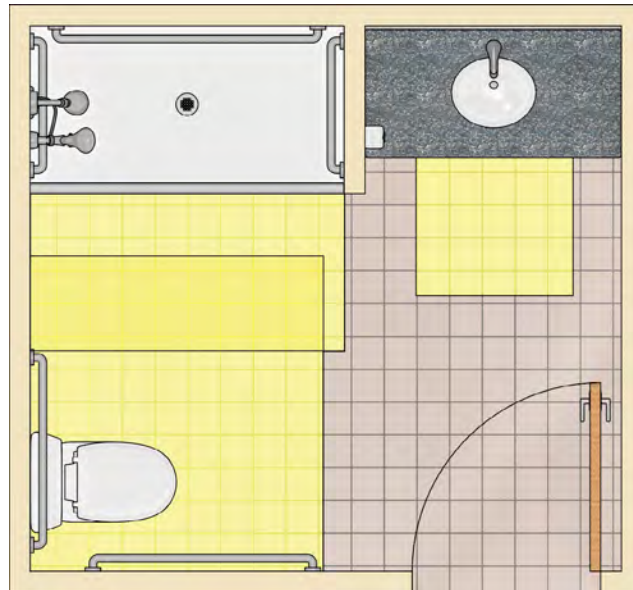

Turning Space

Turning space is required in the room (60" diameter circle or a T-shaped space). The turning space can overlap fixture clearances, and doors can swing into the turning space under any condition. Elements with compliant knee and toe space, such as a lavatory, can partially overlap the turning space.

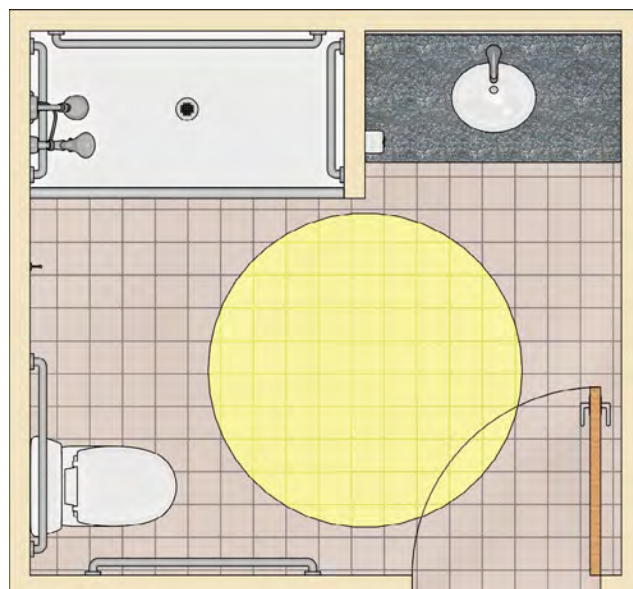

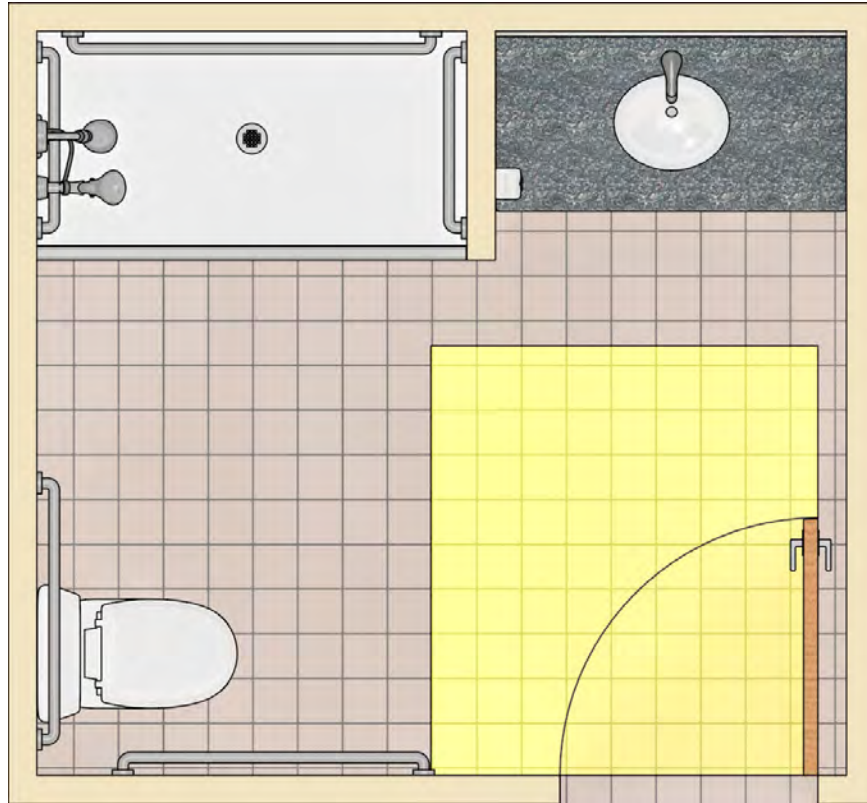

The door maneuvering clearance can be offset up to 8" from the face of the door. Elements, such as grab bars, that can fit within this offset are permitted so long as they do not protrude into the minimum maneuvering clearance.

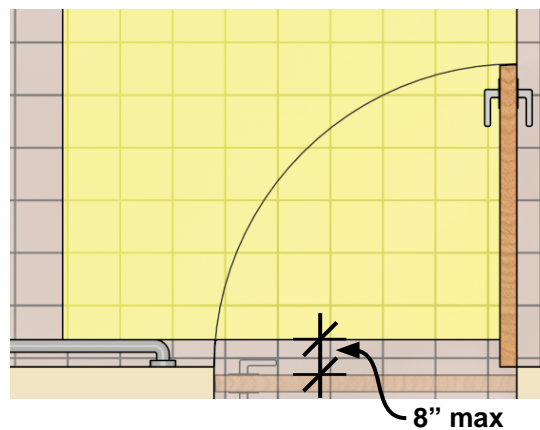
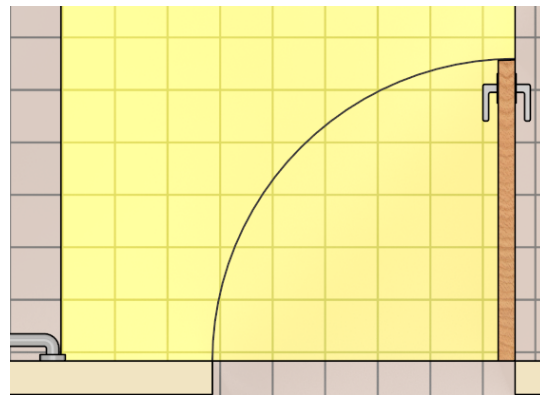

Bathroom with Alternate Roll-In Shower Compartment

This example shows a single-user bathing facility with an alternate roll-in shower compartment that is equipped with a folding seat.

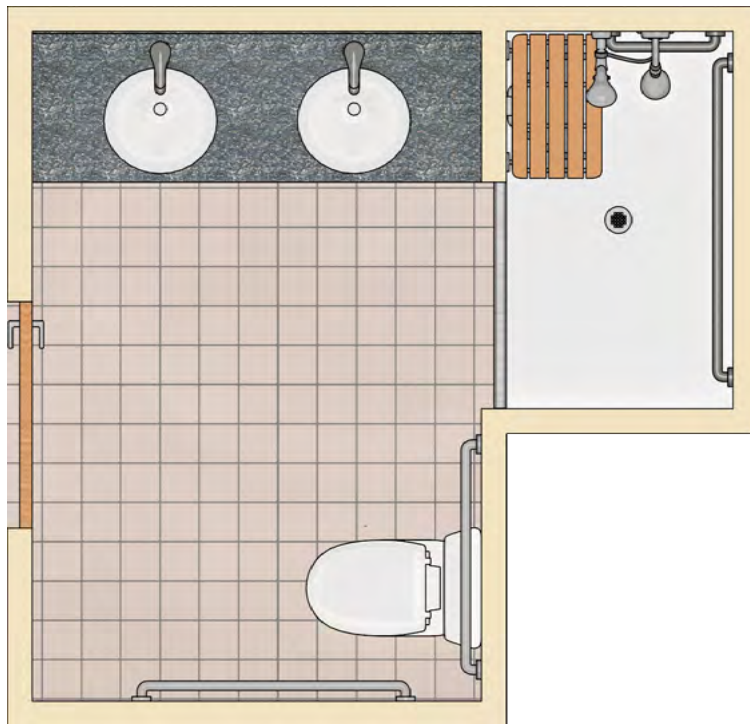

Fixture Clearances and Clear Floor Space Beyond Door Swing

An accessible route must connect to the entry of the alternate roll-in shower compartment, but additional clearance at the fixture is not required. At least one lavatory must provide the required clearance. Since the door swings into the clearance of one fixture (the water closet), an unobstructed clear floor space 30" minimum by 48" minimum is required in the room beyond the door swing. This provides space in single-user facilities to enter the room and clear the door. The location or orientation of the space is not specified, but it should be easy to occupy upon entry into the room.

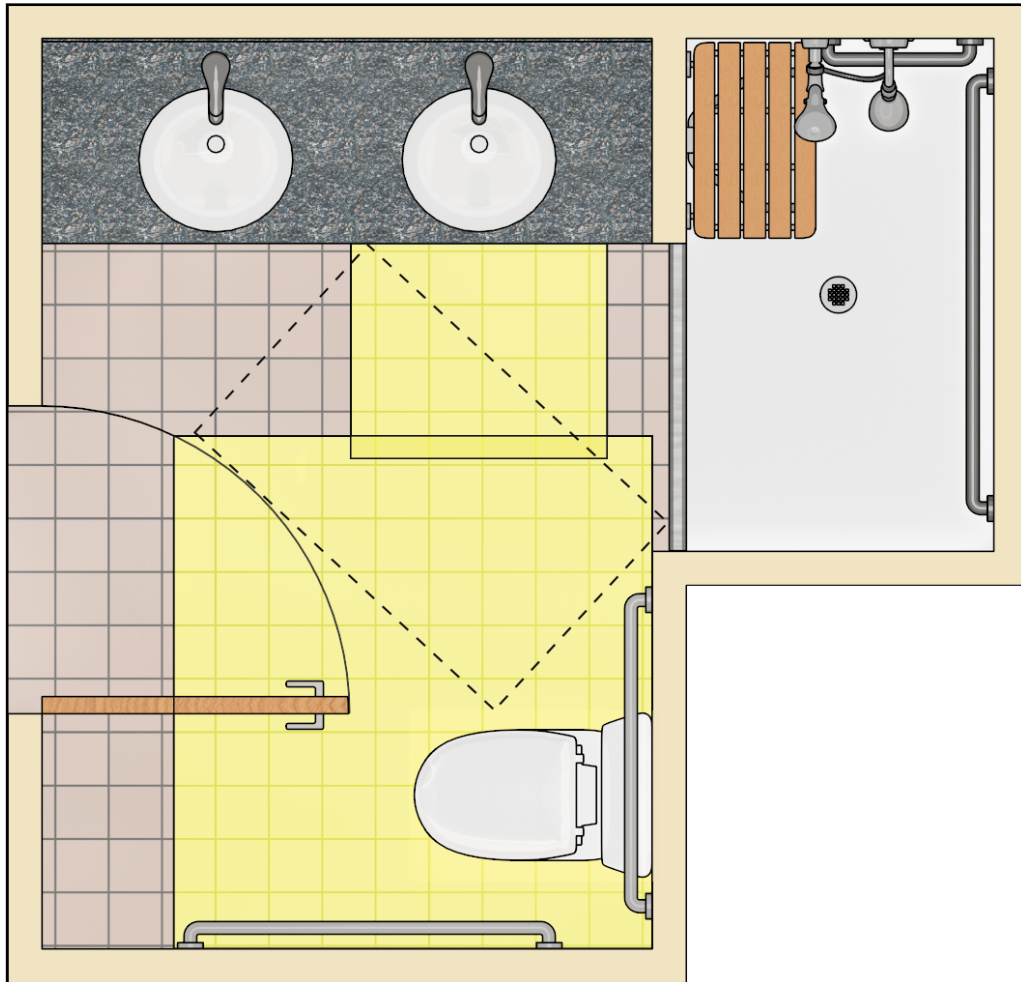

Turning Space

As noted above, doors can swing into the turning space in all cases. While elements with compliant knee and toe space can partially overlap the turning space, keeping the turning space entirely clear enhances usability.

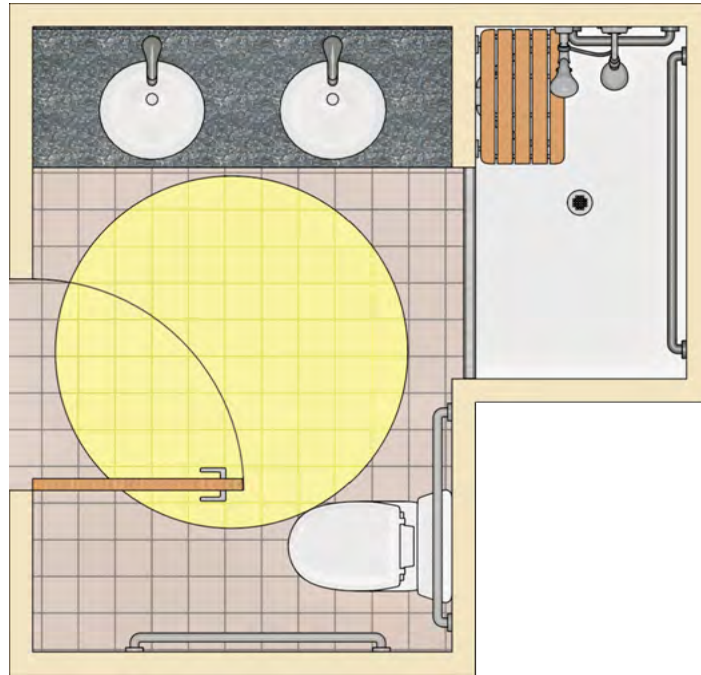

Door Maneuvering Clearance

The door maneuvering clearance must always be clear of any fixtures or elements.

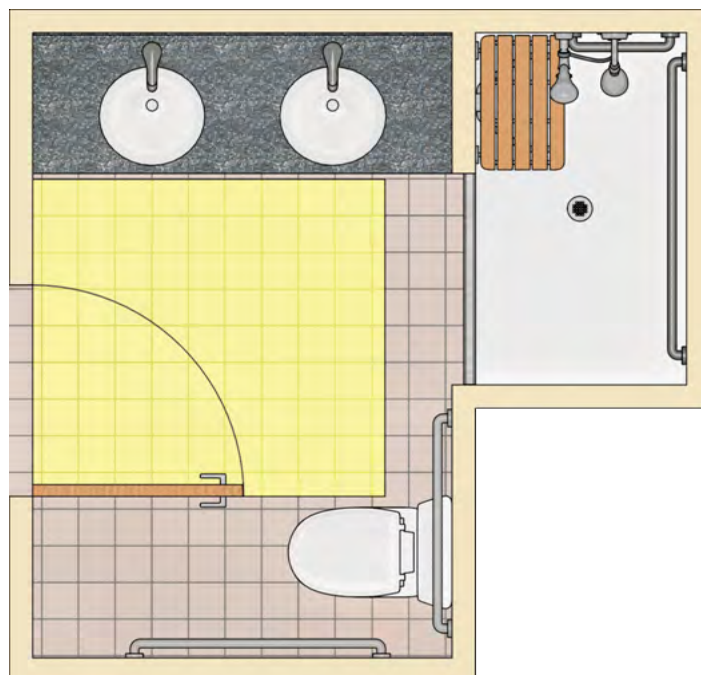

Bathroom with a Bathtub

A bathtub can be provided instead of a shower compartment. Compliant bathtubs must have either a removable in-tub seat as shown here or a permanent seat.

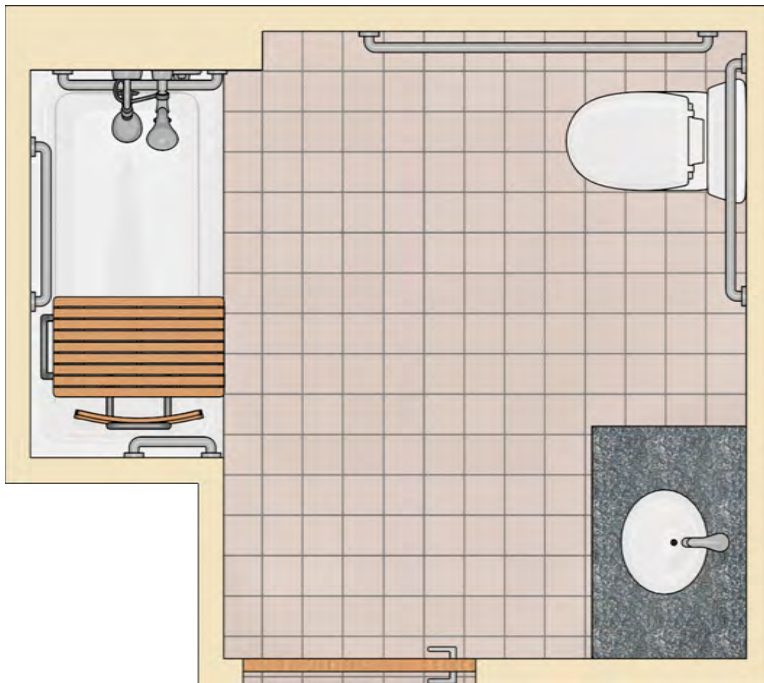

Fixture Clearances and Clear Floor Space Beyond Door Swing

An unobstructed clear floor space 30" minimum by 48" minimum is required in this design because the door swings into fixture clearances (lavatory and bathtub). (In residential dwelling units, a lavatory adjacent to the water closet can overlap a portion of the water closet clearance if the clearance depth is increased by 10", but keeping the space beside the water closet clear provides better access by allowing positioning for side transfers).

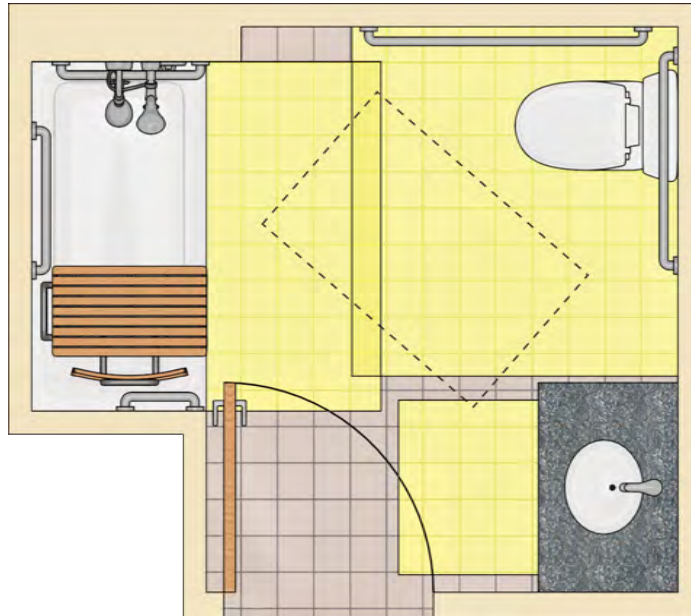

Option: Bathtub with a Permanent Seat

Bathtubs with a permanent seat require more clearance. The clearance must extend the full length of the bathtub and seat and at least 12" beyond the seat to allow proper alignment for transfer.

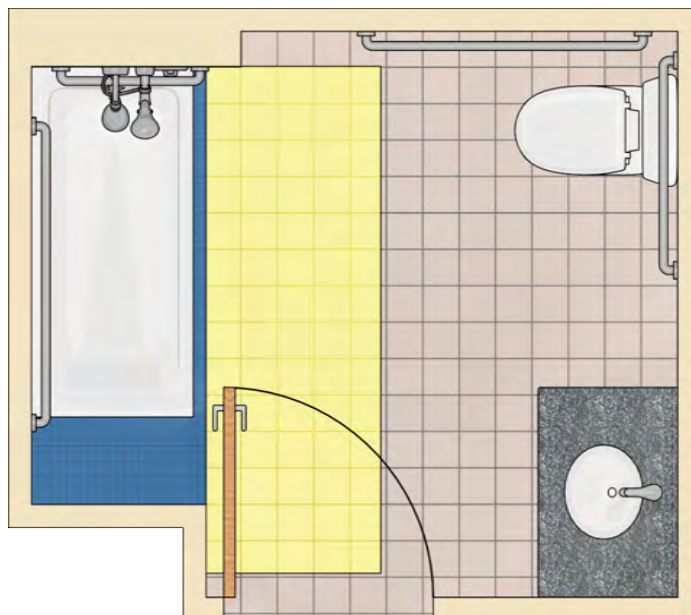

Turning Space

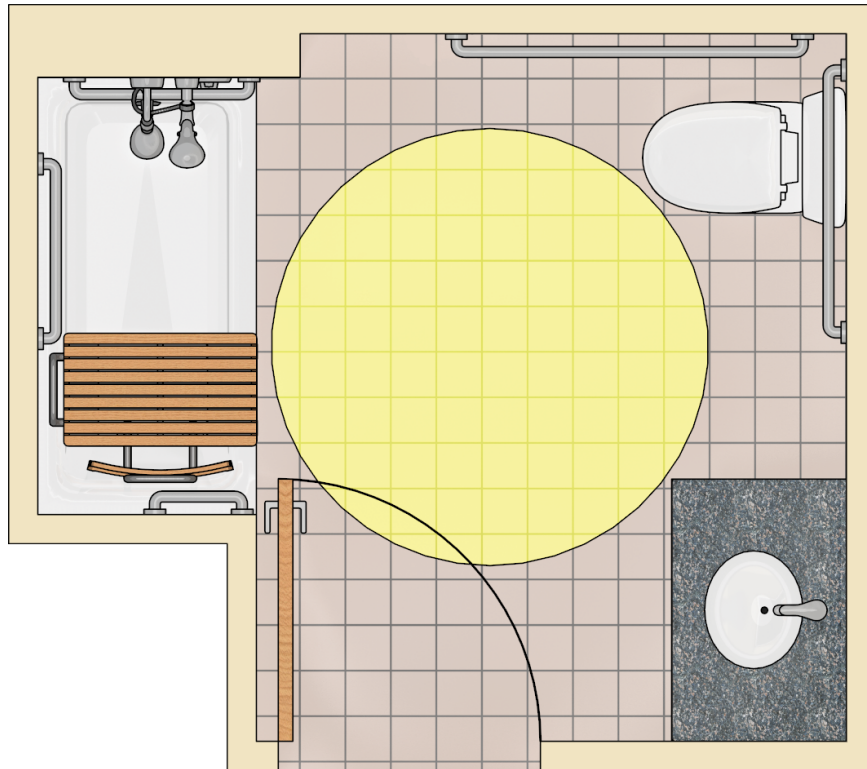

Door Maneuvering Clearance

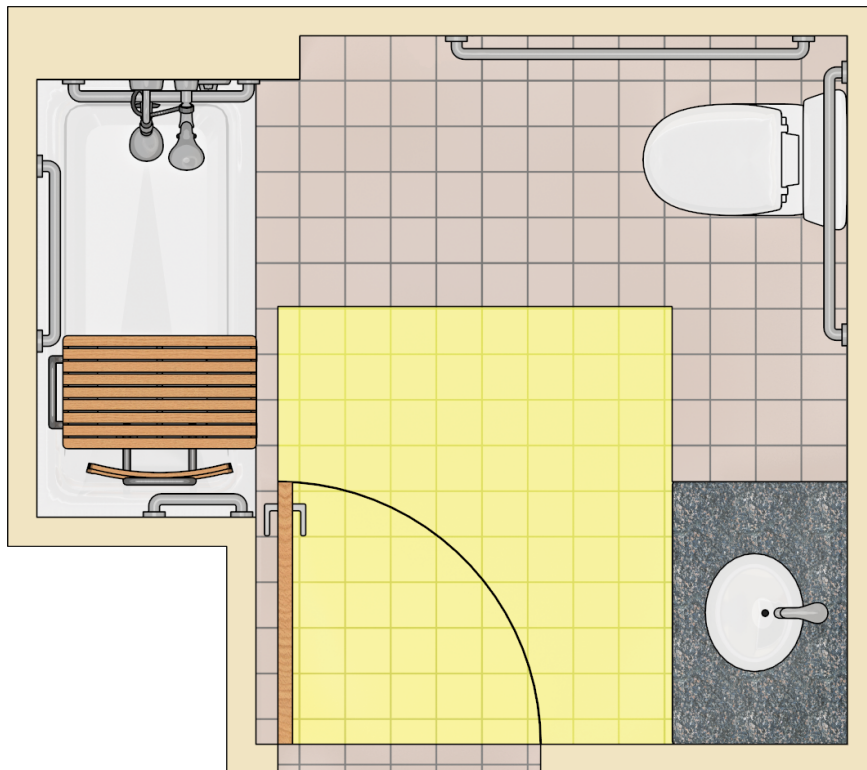

Bathroom with Transfer Shower Compartment and Bathtub

Only one bathtub or shower compartment is required to comply in a bathing facility. If a bathroom has a separate bathtub and shower compartment, providing access to both is advisable for greater access but not required. In this configuration, providing the required clearance at the transfer shower does not impact the size of the room. Transfer shower compartments must have a seat.

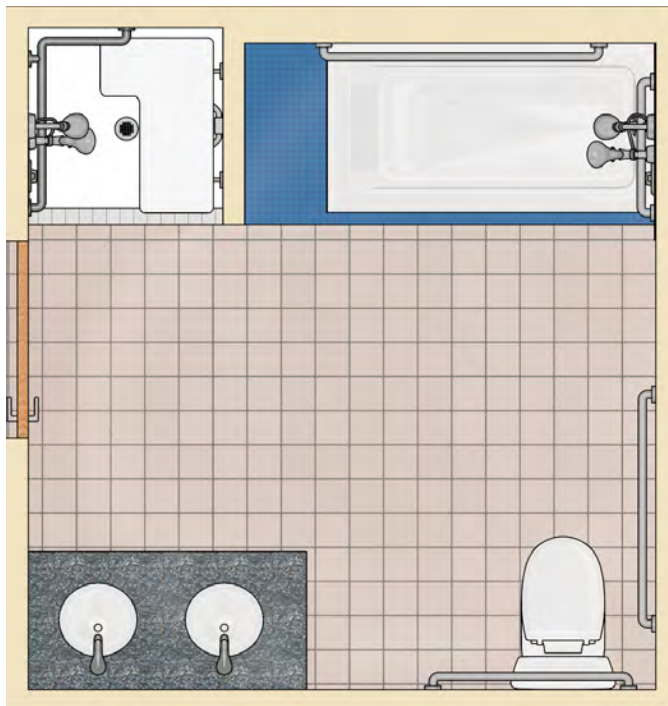

Fixture Clearances and Clear Floor Space Beyond Door Swing

Since this bathtub has a permanent seat, the required clearance extends at least 12" beyond the head end wall. Similarly, the clearance at the transfer shower must extend the same distance beyond the seat wall. The shower and bathtub clearances partially overlap. The door swings into these clearances, and the required unobstructed wheelchair space beyond the door swing is easily accommodated in this design.

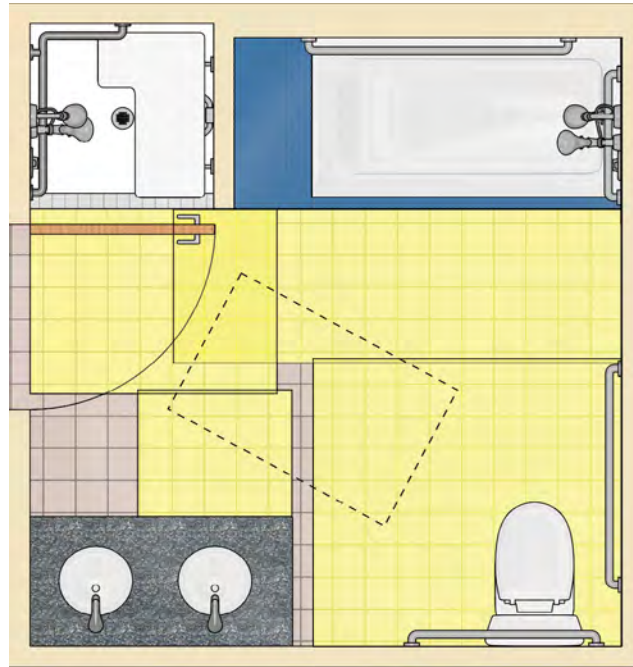

Turning Space and Door Maneuvering Clearance

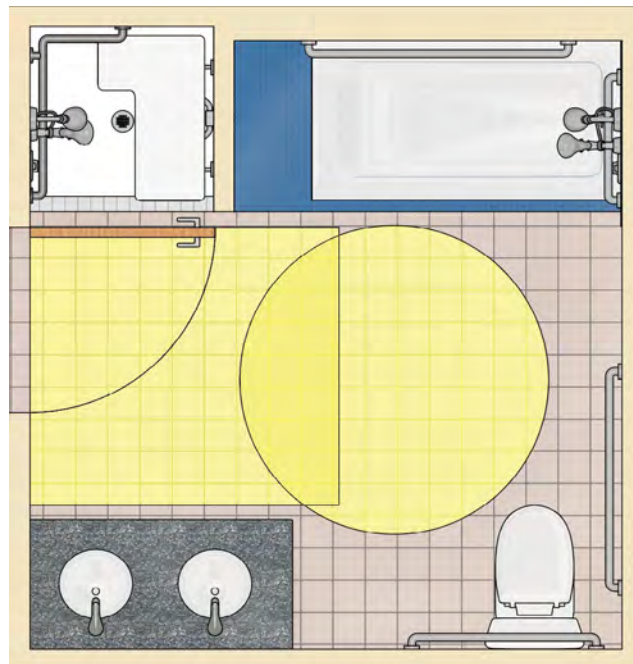

Multi-User Bathroom with Transfer Shower Compartments

In multi-user bathing facilities, as in single-user bathrooms, the requirements are based on the type and number of bathing fixtures and elements provided.



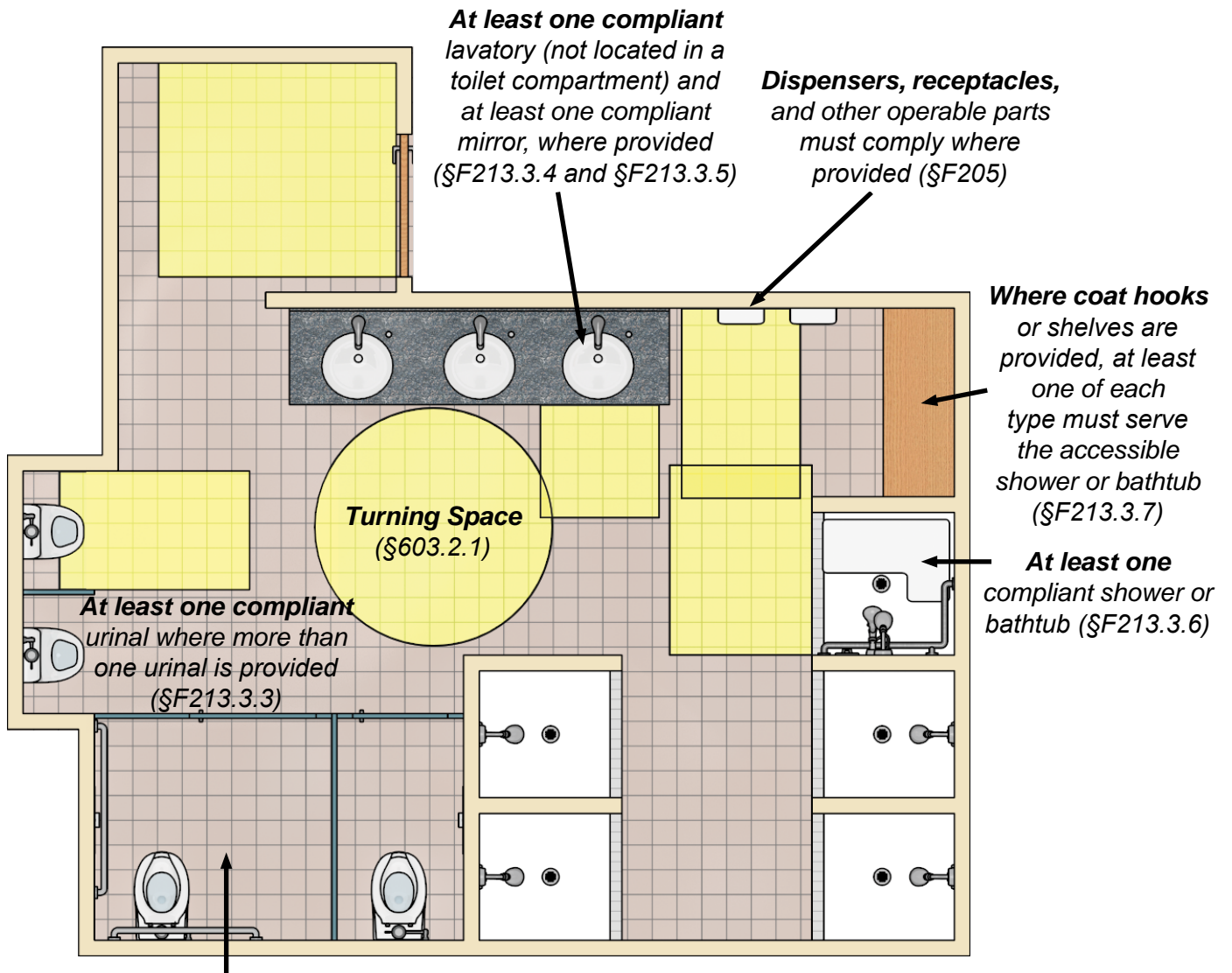

At least one wheelchair accessible toilet compartment (§F213.3.1), including door maneuvering clearance at the compartment door

At least one ambulatory accessible toilet compartment in bathing rooms with at least 6 toilet compartments or where the combined total of toilets and urinals is at least 6 fixtures (§F213.3.1)

Common Questions



Bathing Rooms

Are bathing rooms that serve employees but not the public required to be accessible?

Yes. Public and common use bathing rooms, including those used exclusively by employees, must comply. Private bathrooms for a single occupant accessed only through a private office are permitted limited exceptions for certain access features, such as the later installation of grab bars if walls have blocking or are reinforced.

Is access required to a unisex bathing room that is provided in addition to accessible men's and women's bathing rooms?

Yes. Unisex bathing facilities must be accessible, including where they are provided in addition to accessible men's and women's bathing facilities.

Can access be provided to a unisex bathing room instead of to separate sex bathing rooms?

If men's and women's bathing rooms are provided, they must be accessible even if a unisex bathing room is also provided. However, in alterations when it is technically infeasible to make existing men's and women's bathing facilities comply, an accessible unisex bathing room can be provided instead if it is located on the same floor and in the same area as the men's and women's bathing facilities (§F213.2, Ex. 1).

If a bathing facility has multiple shower compartments or bathtubs located in separate rooms for privacy, how does scoping apply?

If multiple shower compartments or bathtubs are provided in a multi-user shower or bathing room, then at least one shower compartment or bathtub must comply (§F213.3.6), including where showers or tubs are enclosed by full-height partitions for privacy. If single-user bathing rooms are provided in a cluster and accessed directly from a common use corridor or hallway, then each is required to comply as a separate bathing room. Where portable bathing units are provided, at least 5% at each cluster must comply (§F213.2).

Can bathing rooms be designed for assisted use instead of independent access?

In licensed medical care and long-term care facilities, bathing rooms that are part of accessible patient or resident sleeping rooms must comply. The Standards cover independent accessibility and do not address design for use that is assisted by medical or resident care personnel. Design features for assisted use that conflict with requirements of the Standards can be provided in those bathing rooms that are not required to meet the Standards. Any departure from the standards requires a waiver or modification (§F103). The agencies that implement the ABA Standards (the Department of Defense, the Department of Housing and Urban Development, the General Services Administration, and the U.S. Postal Service) have authority to grant modifications and waivers on a case-by-case basis where "clearly necessary."

Can bathing room doors swing into turning space and fixture clearances?

Bathroom doors can swing into the turning space. They cannot swing into the clearance required at plumbing fixtures, except at single user bathing rooms where unobstructed wheelchair space is provided in the room beyond the arc of the door swing (§603.2.3, Ex. 2). In addition, doors can swing into fixture clearances at single-occupant bathing rooms accessed only through a private office and not for common use if the swing of the door can be reversed (§603.2.3, Ex. 1).

Must bathing rooms be identified by the International Symbol of Accessibility (ISA)?

Labeling accessible bathing rooms with the ISA is required only where inaccessible bathing rooms are present. At least 5% of single user portable bathing units of the same type in each cluster must comply and be identified by the ISA unless all are accessible (§F213.2., Ex. 3, §F216.8). In alterations where existing bathing rooms do not comply, directional signs with the ISA must be provided to indicate the location of the nearest accessible bathing room which must be labeled by the ISA (§F216.8).

In transient lodging facilities, can roll-in showers be provided in those accessible guest rooms not required to have them?

A specified portion of accessible guest rooms in transient lodging facilities with over 50 guest rooms must have a roll-in shower with a folding seat (§F224.2). This shower design is required for transient lodging facilities because it affords users the option to roll in or to transfer to a seat. To provide additional bathing options, the Standards specify transfer showers and/or bathtubs for the other guest rooms required to comply, which are referred to as “Rooms Without Roll-in Showers” (Table 224.2). Roll-in showers are not specified for these other guest rooms. Departures from the Standards require a waiver or modification (§F103) from the appropriate standard-setting agency. It is important that departures from the types of bathing fixtures specified for guest rooms (roll-in showers versus transfer showers or bathtubs) under a waiver or modification provide people with disabilities an equal or greater level of choice. For example, like the required roll-in showers, any additional roll-in showers provided instead of a transfer shower or bathtub should be equipped with seats. Further, offering a choice of standard and alternate roll-in showers will also enhance options, as each has its own benefits; the alternate roll-in shower with a seat is similar to a transfer shower by providing a grab bar opposite the seat that is within reach, while the standard roll-in shower provides easier maneuvering into the shower because the entry is as wide as the compartment. Additionally, accessible guest rooms must be dispersed among the various classes of guest rooms and provide choices in amenities comparable to those afforded other guests (§F224.5). If one type of bathing fixture is provided in a class of guest room, that same type of fixture should be provided in the accessible guest room in that class to ensure an equivalent level of choice in amenities.

Are benches required in bathing facilities?

The Standards require a compliant bench in accessible dressing rooms, fitting rooms, and locker rooms (§803.4). A bench is not required in bathing facilities generally (except those that are part of locker rooms). If changing or dressing rooms are provided in bathing rooms, they must comply as dressing rooms and include a compliant bench. Providing a compliant bench in all bathing rooms will provide greater accessibility.

Shower Compartments

Are seats required in roll-in showers?

Seats are not required in roll-in shower compartments except folding seats that are required to be provided in a portion of accessible guest rooms in transient lodging facilities. Folding seats are recommended in all roll-in showers because they provide options for users. They benefit people with disabilities who prefer to sit and accommodate those who wish to transfer from wheeled mobility aids. Seats (either folding or non-folding) are required in transfer shower compartments.

Are roll-in showers preferred over transfer showers?

Preferences vary among users and each shower type has benefits. Transfer shower compartments always have a seat which is helpful to many people with disabilities, including those who are ambulatory. However, they do not provide any roll-in option for those who prefer not to transfer to a seat. Roll-in showers provide easier access for those who do not wish to transfer. However, many people need to transfer from wheelchairs to either a shower seat or shower chair. For these reasons, designs that afford users options are better, such as equipping all roll-in showers with folding seats. In facilities with multiple bathrooms or bathing facilities, it is generally advisable to provide different types of bathing fixtures to allow more options.

Can transfer shower compartments be larger than 36" by 36"?

No. These are absolute, not minimum, dimensions. The specified size provides sufficient space while keeping the controls and grab bars within reach of the seat. The back wall also provides support at the seat.

Can the corners of prefabricated shower compartments be rounded?

Yes. Shower compartments are measured at the center points (horizontal and vertical) of opposing sides to permit rounded corners.

Is a fixed shower head required in addition to the hand-held shower spray unit?

The Standards require only a hand-held shower spray unit that is also usable in a fixed position. A separate fixed shower head at a standard height can be provided in addition to the hand-held shower spray unit. A fixed shower head at 48" maximum above the shower floor can substitute for a hand-held shower spray unit at shower compartments except in medical or long-term care facilities, transient lodging, or dwelling units.

Can access be provided at gang showers?

Yes. Accessible shower compartments can be incorporated into gang showers provided they meet all applicable requirements.

Can shower grab bars be continuous?

Yes. Grab bars at showers can be continuous or separate.

If separate shower grab bars are provided, must they be at the same height?

Yes. Grab bars required at showers must be installed at the same height (§608.3).

Can a shower grab bar be located on a half wall or wing wall?

Yes. Grab bars, if properly secured, can be located on a half wall or wing wall. However, it is important that adequate wall surface is available to provide support and to keep arms from slipping off the bar. Wall surface that extends the full height of the required 12" clearance above grab bars, or preferably to the standard adult shoulder height for standees, should provide sufficient support in using grab bars.

How close must the grab bar extend to the shower opening?

It is important that the grab bar on the control wall of a transfer shower extend close to the shower entry so that it is usable from outside the compartment for transfer. A maximum horizontal distance between the grab bar and the entry is not specified in the Standards. In standard roll-in showers, grab bars are generally required to extend near the opening; if the shower is considerably deeper than the 30" minimum, grab bars should be lengthened so that they extend to the entry, but this is not required.

How close must the grab bar extend to the corner of the shower compartment?

In roll-in showers, grab bars must be located 6" maximum from adjacent walls. In a transfer shower, grab bars that are split must extend as close as feasible to the adjacent wall (a maximum distance is not specified).

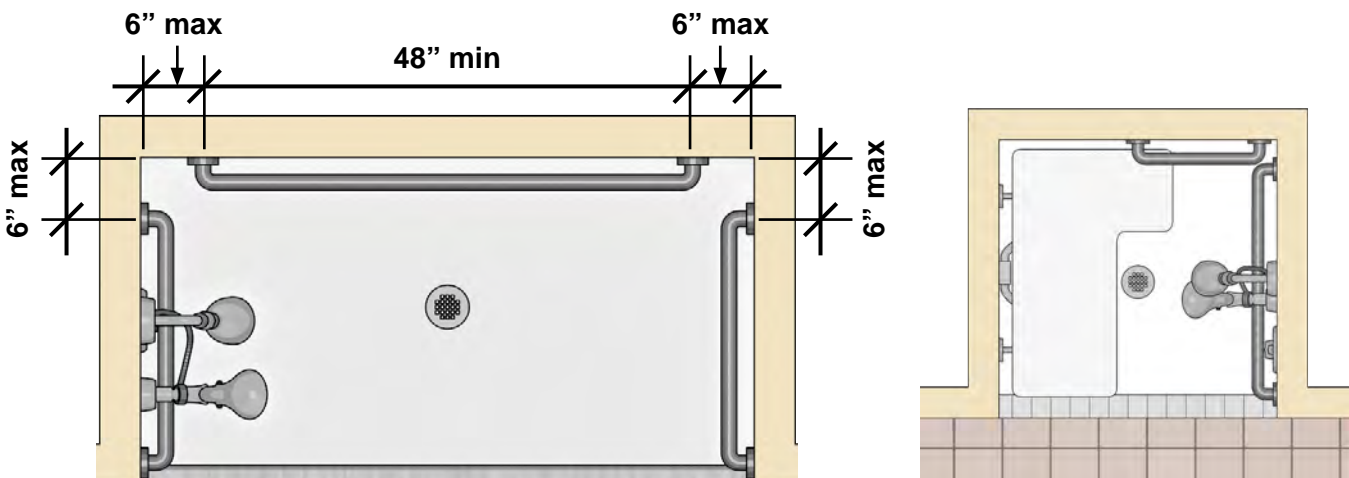

Can shower diverter valves be located on fixed shower heads mounted more than 48" above the shower floor?

No. Shower controls, including diverters for shower spray handheld units, must be within the location specified for shower controls at transfer and roll-in shower compartments. The maximum height is 48" above the shower floor.

Can a handheld shower spray unit be mounted to a vertical bar that provides adjustable positions above a height of 48"?

Yes. Handheld shower spray units can be mounted to vertical bars with adjustable heights. The bar must be located so that the shower spray unit can be positioned within the specified location and maximum 48" height. The vertical bar cannot obstruct the use of grab bars (§608.6); while it can be located within the 12" min. clearance above the grab bar as a shower fitting, it must allow a clearance of at least 1½" above the bar and cannot extend behind the grab bar. Shower spray units should be returned to a lower position so that they remain within accessible reach for other users.

Can accessible shower compartments have doors instead of curtains?

Shower enclosures, including doors, cannot obstruct controls, faucets, shower spray units, or transfer from wheelchairs to transfer seats (§608.8). Shower doors on transfer compartments and standard roll-in compartments will typically fail this test. For example, a swing door on a transfer shower will hinder transfer unless it can swing clear of the required clearance, but it will be very hard to close such a door from the shower seat. A door may be possible on an alternate roll-in shower if the shower opening provides a clear width of at least 36" min. when the door is open 90 degrees.

Are rinsing showers at swimming pools, beaches, and camping areas required to comply as showers?

Shower fixtures located outside bathrooms for use at swimming pools and beaches are not required to comply as showers. The Standards provide requirements for outdoor rinsing showers on federal lands (§1011.7). These requirements address size (60" min. by 60" min. centered on the shower head) and shower spray units. Other types of shower fixtures not located in bathrooms must meet applicable requirements for operable parts, including clear floor space and compliant controls.

Grab Bars and Shower Spray Units

Can grab bar attachments be located at points along the bar instead of at the ends?

Yes. Grab bar attachments can be at points other than the ends of grab bars.

How is the length of grab bars measured?

Grab bar length is measured to the centerline of the return, consistent with industry convention. This also applies to post-mounted grab bars. When attached at points other than the ends (e.g., “European” style grab bars), the length is measured to the end of the bar.

Must grab bars have a peened or other textured surface?

No. The Standards do not require grab bars to have peened or textured surfaces.

Is a vertical grab bar required by the Standards?

No. The ABA Standards do not require a vertical grab bar at bathing fixtures. Vertical bars are helpful and provide support when stepping into bathtubs or showers. The ICC A117.1 standard, which is referenced by the International Building Code, requires an 18” minimum vertical grab bar at transfer showers and bathtubs.

What is a non-positive shut-off for the on/off control on hand-held shower spray units?

The handheld shower spray unit must have a “non-positive shut-off” to prevent cross-connections and other hazards prohibited by plumbing codes. A non-positive shut-off does not completely stop the flow of water so that the main shut-off is still used.

Bathtubs

Do requirements for bathtubs also apply to spa tubs, or tubs used for rehabilitation, physical therapy, or sports training?

The requirements for bathtubs apply only to bathtubs used for bathing. Requirements for spas (§F242.4), which specify access by lifts or transfer walls or systems, apply to spa tubs.

Do the Standards specify the height of bathtub walls?

No. The Standards specify the height of removable and permanent tub seats (17” – 19”) but not the height of tub walls or rims. The outside tub wall should be the same height as permanent tub seats for easier access.



UNITED STATES ACCESS BOARD

Advancing Full Access and Inclusion for All

1331 F Street, NW ▪ Suite 1000 ▪ Washington, DC 20004-1111
(202) 272-0080 (v) ▪ (202) 272-0082 (TTY) ▪ www.access-board.gov

April 2020